



NAGPUR INSTITUTE OF TECHNOLOGY

(Affiliated to RTM Nagpur University & Approved by AICTE New Delhi)

CAMPUS: 13/2, Mahurzari, Near Fetri, Katol Road, Nagpur-441501, India

Email Id: registrar@nit.edu.in Web: www.nit.edu.in Contact No. 09764974144

RTMNU College Code: 315

DTE Code: 4144

AICTE ID : 1-4830701

5.1.2 Following capacity development and skills enhancement activities are organized for improving students' capability in 2023-24

4.Awareness of trends in technology

SN	Name of the capacity development and skills enhancement program	Period (from date - to date)	Number of students enrolled	Name of the agencies/experts involved with contact details
1	3 Days Workshop on latest Technology Trend in AutoCAD Design Software	24-08-2023 to 26-08-2023	38	Prof. Mahesh Kanojiya in association with Admire Tech Vision, Nagpur
2	3 days workshop on KALI Linux	11-10-2023 to 13-10-2023	77	Prof. Nikita Dhanvijay & in association with Harshwardhan Budhala, Alumni
3	2 Days workshop on current trend in IOT & Network Security	29-02-2024 to 01-03-2024	60	Mr. P M Wasu, Director CMS IT Services, Nagpur
4	2 Day Workshop on CNC Programming	01-02-2024 to 02-02-2024	36	Prof. G. P. Dhalwar and Prof.R. A. Deshmukh & in association with MSME Technology, Centre-IGTR
5	2 days Workshop on Simulation of Electrical Machine by using MATLAB	22-09-2023 to 23-09-2023	38	Dr.Sanjay Bodkhe, Professor and Head(EE),RCoEM, Nagpur
6	2 days workshop on latest trend in Website Designing	04-08-2023 to 05-08-2023	90	Prof. S.G. Gadhave, SVPCOE, Nagpur
7	Two Day workshop on Stadd Pro in Structural Design technology	10-10-2023 to 11-10-2023	55	Mr. Swapnil Udapurkar, Center Head Ms Priyanka kanojiya, Structural Design Engineer Ms Bhagyashree Selore, Design



NAGPUR INSTITUTE OF TECHNOLOGY

(Affiliated to RTM Nagpur University & Approved by AICTE New Delhi)

CAMPUS: 13/2, Mahurzari, Near Fetri, Katol Road, Nagpur-441501, India

Email Id: registrar@nit.edu.in Web: www.nit.edu.in Contact No. 09764974144

RTMNU College Code: 315

DTE Code: 4144

AICTE ID : 1-4830701

				Engineer CADD Center Nagpur
8	2 days workshop on Drawing Software for Electrical Engineers	29-03-2024 to 30-03-2024	32	Er. Akash Thakre, Electrical Design Engr Astral Informatic Pvt Ltd



PRINCIPAL
Nagpur Institute of Technology,
Nagpur - 441501.





NAGPUR INSTITUTE OF TECHNOLOGY

(Affiliated to RTM Nagpur University & Approved by AICTE New Delhi)

CAMPUS : 13/2, Mahurzari, Near Fetri, Katol Road, Nagpur-441501, India

Email Id : registrar@nit.edu.in Web : www.nit.edu.in Contact No. 09764974144

RTMNU College Code: 315

DTE Code: 4144

AICTE ID : 1-4830701

Department of Mechanical Engineering

Date: 21/08/2023

NOTICE

All students of 4th, 6th & 8th semesters are informed that **Department of Mechanical Engineering** is organizing 3 Days Workshop on Auto CAD Design Software organised in Association with Admire Tech Vision, Nagpur.. All are informed to remain present on 24/08/2023 in CAD Lab.

Prof. D. M. Lade
Coordinator

Dr. V N Kalbande
HOD, ME.

Mechanical Engineering
Nagpur Institute of Technology, Nagpur

Copy To:

- HOD, ME
- Class Incharge 3rd & 4th year respectively.



NAGPUR INSTITUTE OF TECHNOLOGY

(Affiliated to RTM Nagpur University & Approved by AICTE New Delhi)

CAMPUS : 13/2, Mahurzari, Near Fetri, Katol Road, Nagpur-441501, India

Email Id : registrar@nit.edu.in Web : www.nit.edu.in Contact No. 09764974144

RTMNU College Code: 315

DTE Code: 4144

AICTE ID : 1-4830701

Department of Mechanical Engineering

Date: 27/08/2023

Workshop Report

Session : 2023-2024
Date & duration : 24-08-2023 To 26-08-2023
Title : 3 Days Workshop on AutoCAD Design Software
Name of Expert : Admire Tech Vision, Nagpur,
Participants : Student: 32 (2nd, 3rd & 4th Year)
Objective of program : To introduce the Design Software
Coordinated by : Prof. G. P. Dhalwar

Event Details:

Mechanical Engineering Departement organised 3 Days Workshop on AutoCAD Design Software organised in Association with Admire Tech Vision, Nagpur. Dr. Vijay Kalbande delivered opening remarks. Prof. Mahesh Kanojiya, Prof Deepali Lade, Prof. Rohan Deshmukh and Prof. Ganshayam Dhalwar coordinated the event.

Glimpses of Activity :



Day 01



Day 02



Day 03



DM Lade

Prof. D. M. Lade
Coordinator

Dr. V N Kalbande

Dr. V N Kalbande

HOD, ME

Mechanical Engineering
Nagpur Institute of Technology, Nagpur



NAGPUR INSTITUTE OF TECHNOLOGY

(Affiliated to RTM Nagpur University & Approved by AICTE New Delhi)

CAMPUS : 13/2, Mahurzari, Near Fetri, Katol Road, Nagpur-441501, India

Email Id : registrar@nit.edu.in Web : www.nit.edu.in Contact No. 09764974144

RTMNU College Code: 315

DTE Code: 4144

AICTE ID : 1-4830701

Department of Mechanical Engineering

Date & duration : 24-08-2023 To 26-08-2023

Title : 3 Days Workshop on AutoCAD Design Software

III sem Student Roll List

Roll No.	Students Name	Attaind ance	Roll No.	Students Name	Attain dance
201	AASTHA SANJAY TOTALWAR	P	238	PRANAY GHANSHYAM NANHE	
202	AMISHA SUKHRAM MATRE		239	PRANAY HEMRAJ HARINKHEDE	P
204	HARSHADA K BAWANE	P	240	PRATUSH S WADHI	
205	MEGHA NILESH NANHE	P	241	RAM RAMESH PAWAR	
206	PRERNA M MAHALLE		242	SAHIL RAJKUMAR CHAUDHARI	
207	SAMIKSHA CHINTAMAN BHALERAO		244	SANKET RAMKRISHNA TOHANE	P
208	SHWETA FATTU DHANVIJAY	P	245	SANTOSH DIWAKAR RAUT	
209	SIMA TULSHIRAM NARNAWARE		246	SHRUJAL PRANAY MANKAR	
210	TEJASVI MANOJ JAYRAJ		247	SRUJAL SANJAYRAO KAUTKAR	
211	AARADHYA SHANKAR SHELOKAR	P	248	SUMEDH DHANDRA LADE	
213	ABHISHEK PUNDLIK VAIDYA		249	UTKARSH K SOMKUWAR	
214	ABHISHEK R SHAHU		250	VAIBHAV T BALPANDE	
216	ANSH SUNIL DONGRE		251	VANSH RAVINDRA BHINGARE	
217	ANUJ MURLIDHAR KHANDEKAR		252	VIRAJ RAJESH BALNE	
218	ARPIT PRAMOD DARVEKAR		253	LOKITA TEMBHURNE	P
219	ASHISH BABANRAOJI GHAGARE		254	YASH NARESH ZODE	
222	AYUSH M CHAUDHARI		255	PUNIT MANMOHAN DWIWEDI	
225	GAURAV ISHWAR DATE		256	VIKAS GHANSHYAM MISHRA	
226	GAURAVKUMAR O VISHWAKARMA	P	257	KRUNAL LAXMIKANT HAJARE	P
228	HIMANSHU RAVINDRA WANKHEDE		258	ROHAN NARESH PANKAJ	
229	JAY MORESHWAR RAUT		259	SUMIT SUNIL GUPTA	
230	KAUSHAL KAILASH YERPUDE		260	LOKHANDE SANKALP PRAMOD	
231	KUNAL LOMESH POUNIKAR	P	261	HARSHAL KISHOR DESHMUKH	P
234	NISHANT S NAGPURE		264	PRATHMESH A SINGANJUDE	
235	PAVAN GANGARAM JADHAO		265	ADITYA JAGDISH HATHITHELE	
236	PIYUSH R KANOJIYA	P			
237	PIYUSH SURESH GAIKWAD				

Prof. D. M. Lade
Coordinator

Dr. V N Kalbande
HOD, ME
Mechanical Engineering
Nagpur Institute of Technology, Nagpur



NAGPUR INSTITUTE OF TECHNOLOGY

(Affiliated to RTM Nagpur University & Approved by AICTE New Delhi)

CAMPUS : 13/2, Mahurzari, Near Fetri, Katol Road, Nagpur-441501, India

Email Id : registrar@nit.edu.in Web : www.nit.edu.in Contact No. 09764974144

RTMNU College Code: 315

DTE Code: 4144

AICTE ID : 1-4830701

Department of Mechanical Engineering

Date & duration : 24-08-2023 To 26-08-2023

Title : 3 Days Workshop on AutoCAD Design Software

V sem Student Roll List

CR N	Name of Stuent	Attaindan ce	CR N	Name of Stuent	Attaindan ce
301	Astha Chintaman Bhalerao		321	Praful Gokul Shengaye	P
302	Durva Kothiram Pelane	P	322	Prashnajt Vinod Sakharkar	
303	Khushi Sunil Gour		323	Prathamesh Kamal Shahu	P
304	Laxmi Ramesh Thakur		324	Preshit Surendra Dhabarde	
305	Nagkanya M. Gaikwad	P	326	Raj Govind Humne	P
306	Prajakta Bandu Gedam		327	Rizwan Tabarak Ansari	
307	Vaishnavi Anil Gujare		328	Sagar Dilip Sahare	P
308	Abhay Sharad Gedam		329	Sahil Satendra Godbole	
309	Akshay Nilkanth Dandekar		330	Saurabh Balu Gudhe	
310	Ankush Ashok Baheshwar	P	331	Shubham Ranjit Bawane	P
311	Ayaz Kalim Sheikh		332	Sujal Kamlesh Gajbhiye	
312	Bhairav Manoharrao Helonde		333	Suraj Chandrashekhar Mouje	
313	Bhavesh Sanjay Petkar		335	Utkarsh Shivshankar Dhore	
314	Dishant Krushanji Lokhande	P	336	Utkarsh Umesh Ramteke	
316	Harshal Sanjay Ganar		337	NIKHIL AMBADAS KOTJAWALE	
317	Kalash Babarao Bansod	P	338	Vishal Satyabhan Chaudhari	P
318	Manthan Gopal Thambuskar				
319	Mithilesh Hukumchand Patle				
320	Pavan Mulchand Patil	P			

DM Lade

Prof. D. M. Lade
Coordinator

Dr. V N Kalbande

Dr. V N Kalbande
HOD, ME

Mechanical Engineering
Nagpur Institute of Technology, Nagpur



NAGPUR INSTITUTE OF TECHNOLOGY

(Affiliated to RTM Nagpur University & Approved by AICTE New Delhi)

CAMPUS : 13/2, Mahurzari, Near Fetri, Katol Road, Nagpur-441501, India

Email Id : registrar@nit.edu.in Web : www.nit.edu.in Contact No. 09764974144

RTMNU College Code: 315

DTE Code: 4144

AICTE ID : 1-4830701

Department of Mechanical Engineering

Date & duration : 24-08-2023 To 26-08-2023

Title : 3 Days Workshop on AutoCAD Design Software

VII TH SEM LIST SESSION : 2023-24

CR N	Name of Stuent	Attaind ance	CR N	Name of Stuent	Attain dance
401	Payal Krushnaji Lokhande		433	Mahesh Vinod Dhapke	
402	Pranali Ravindra Meshram	P	435	Piyush Bhagwat Tadose	
403	Pratiksha Dinesh Manwatkar		436	Piyush Mahadeo Nikode	
404	Priyanka Vinayak Tumlam		437	Piyush Umesh Puri	
405	Rajshi Anklesh Indurkar	P	438	Prajwal Nakade	
406	Sagar Nepal Chamlate		439	Prajwal V. Bawane	
407	Sanskriti S.Chokhandre		440	Rahul Kanhiyalal Sahani	
408	Shravani Dinesh Kadu	P	441	Rishabh Vidhyadhar Chikhale	
409	Tusharika Manohar Mahalle		442	Rishabh Yadkaran Sakhare	
410	Abhilash Bharat Murar		443	Rohit Manohar Shendre	
413	Aditya Jagannath Kelwade		444	Rohit Mukunda Kathane	
414	Aditya Vijayrao Boratkar		446	Sahil Bagde	
415	Akash Kundlik Mene	P	447	Sahil Fulzele	
416	Akash Maroti Shendre		448	Sahil Raju Yenkeswar	
417	Aman Ansari		449	Santvan Rajesh Jagtap	
418	Amar Adnyan Pendram	P	450	Satyendra Sadashiv Upwanshi	
419	Amin Mammusabu Pathan		451	Saurabh Ganesh Hasbe	
420	Aniruddh Laxman Sonkamble		452	Saurabh Marotrao Mohankar	
421	Aniruddha Sonekar	P	453	Saurabh Omkar Kaurati	
422	Ankush Ganesh Chaudhary		454	Savin Surjuse	
424	Anush Uttamkumar Petkar		455	Sumit Bhawarkar	
425	Ayush Nandu Ganvir	P	456	Sumit Kumar Yadav	
426	Ayush Yadav		457	Swapnil Ashok Khonde	
427	Ganesh Sudam Raut		458	Ujwal Satish Lakhde	
428	Gaurav Rajeram Diwate		459	Vaibhav Vasudev Thakre	
429	Harshal Shravan Zade	P	460	Vinay Arkilla	
430	Ishant Harish Lokhande		461	Vivek Ashok Wankhede	
431	Jitesh Munjewar		462	Yash Athod	
432	Kunal Madhukar Wasnik		463	Sagar Dilip Shingade	

Prof. D. M. Lade
Coordinator

Dr. V N Kalbande
HOD, ME
Mechanical Engineering
Nagpur Institute of Technology, Nagpur



NAGPUR INSTITUTE OF TECHNOLOGY

(Affiliated to RTM Nagpur University & Approved by AICTE New Delhi)

CAMPUS: 13/2, Mahurzari, Near Fetri, Katol Road, Nagpur-441501, India

Email Id : registrar@nit.edu.in Web : www.nit.edu.in Contact No. 09764974144

RTMNU College Code: 315

DTE Code: 4144

AICTE ID : 1-4830701

Department of Computer Science & Engineering

Session: 2023-24

Date:10/10/2023

Notice

All the students of III semester CSE are hereby informed that the, CSE Department is organizing Workshop on “Kali Linux” is schedule on dated from 11/10/2023 to 13/10/2023. All the students must be present at the mentioned venue & time below.

Time: 2.00 p.m to 4.00 p.m.

Venue: CSE Computer Lab

Prof. A. Gahankari
Event Coordinator

Dr. Shrikant Zade
Head, CSE Deptt.
H.O.D.
Computer Science & Engineering Dept.
Nagpur Institute of Technology
Nagpur.

Copy To :

1. Circulation in Class of III Semester
2. Notice Board
3. Office File



NAGPUR INSTITUTE OF TECHNOLOGY

(Affiliated to RTM Nagpur University & Approved by AICTE New Delhi)

CAMPUS: 13/2, Mahurzari, Near Fetri, Katol Road, Nagpur-441501, India

Email Id : registrar@nit.edu.in Web : www.nit.edu.in Contact No. 09764974144

RTMNU College Code: 315

DTE Code: 4144

AICTE ID : 1-4830701

Department of Computer Science & Engineering

Session: 2023-24

Date: 14/10/2023

Activity Report

Activity Title	:	Kali Linux
Expert Detail	:	Mr. HarshvardhanBuddhala Alumini of NIT, Nagpur
Date & Time	:	11-10-2023 to13-10-20232:00pmt04:15pm
Mode of Conduction	:	Offline
Participants	:	Student:77 Faculty:02
Objective of program	:	To help Students to understand practical approaches on Kali Linux
Program coordinator	:	Prof.NikitaDhanvijay

The Department of Computer Science and Engineering of NIT, Nagpur has organised a Three days' Workshop from 11th to 13th October 2023 . The workshop aimed to provide students with in-depth knowledge and practical experience of KaliLinux.

1. Day 1 : Introduction of Kali linux
2. Day2:Information about IP address and Hacking
3. Day3:Overview of essential tools and commands in KaliLinux

Thiswork shopprovedtobeacomprehensiveandvaluable.Studentswereprovided with dedicated lab environments to perform practical exercises using Kali Linux.The work shop on approach and Interactive sessions ensured active engagement and facilitated practical application of the concepts learned.



NAGPUR INSTITUTE OF TECHNOLOGY

(Affiliated to RTM Nagpur University & Approved by AICTE New Delhi)

CAMPUS: 13/2, Mahurzari, Near Fetri, Katol Road, Nagpur-441501, India

Email Id : registrar@nit.edu.in Web : www.nit.edu.in Contact No. 09764974144

RTMNU College Code: 315

DTE Code: 4144

AICTE ID : 1-4830701

Department of Computer Science & Engineering

Session: 2023-24

Following are the glimpses of the workshop

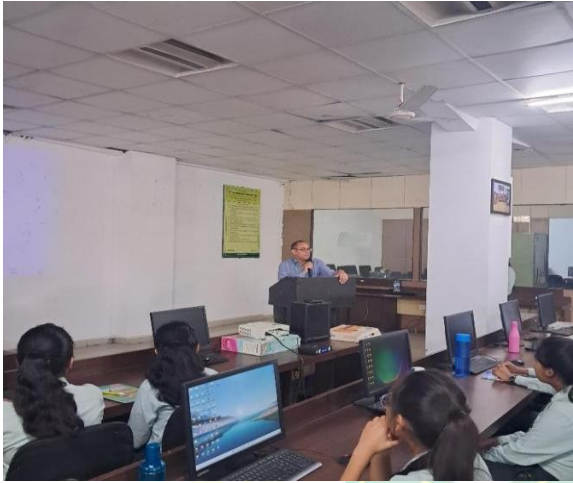

A. Gahankari
Prof. A. Gahankari
Event Coordinator

NIT
★ ★ ★

Dr. Shrikant Zade
Dr. Shrikant Zade
Head, CSE Deptt.
H.O.D.
Computer Science & Engineering Dept.
Nagpur Institute of Technology
Nagpur.

Nagpur Institute of Technology



NAGPUR INSTITUTE OF TECHNOLOGY

(Affiliated to RTM Nagpur University & Approved by AICTE New Delhi)

CAMPUS: 13/2, Mahurzari, Near Fetri, Katol Road, Nagpur-441501, India

Email Id : registrar@nit.edu.in Web : www.nit.edu.in Contact No. 09764974144

RTMNU College Code: 315

DTE Code: 4144

AICTE ID : 1-4830701

Department of Computer Science & Engineering

Session: 2023-24

Department of Computer Science & Engineering

Roll No	Name	Attendance 11/10/2023	Attendance 12/10/2023	Attendance 13/10/2023
1	ACHAL PRAKAASH JAMGADE	P	P	P
2	ADITI SHANKAR GAURE	P	P	P
3	ANJALI MANOJ PARATE	P	P	P
4	ANJALI RAVINDRA NINAAVE	P	P	P
5	ASTHA DILIP KAMBLE	P	P	P
6	KASHISH PRUTHVIRAJ JAWADE	P	P	P
7	MAYURI PRAMOD NAGPURKAR	P	P	
8	MEGHA SANJAY GOBADE		P	P
9	MRUNALI GAJANAN UMAK	P		P
10	NIKITA GHANSHYAM JOSHI		P	
11	PRANJALI SHESHRAO KADAM	P		
12	RUSHIKA RAJU DAHAKE	P	P	P
13	SANSKRUTI CHAKRAPANI BIRADAR	P	P	
14	SANSKRUTI VILASRAO PATIL			
15	SEJAL DIWAKAR PELNE		P	
16	SHIKHA PREMKISHOR CHAUHAN	P		
17	SHRAVANI SHARAD DUDHBADE	P	P	P
18	SHRAVYA RAMESH KOTAWAR	P	P	
19	SHREYA GANESH KOHAD		P	P
20	SHRUTI HARISH JAIWAR	P	P	P
21	TEJAL GIRIDHAR TIJARE	P	P	P
22	TEJAL KESHAO KAWALE		P	
23	TRUPTI NARESH TEKAM	P		
24	VAIBHAVI PRAKASH DHENGE		P	P
25	VAISHNAVI DILIP UGHADE	P	P	P
26	VAISHNAVI ASHOK NAKTODE			
27	VAISHNAVI DIGAMBAR GETME	P	P	P
28	VINA HEMANT CHACHERKAR	P	P	
29	AAKASH KRISHNAKUMAR SINGH			
30	ABHISHEK DEWANAND KANOJE	P	P	
31	ABHISHEK SAHEBRAO WANDHARE			P
32	ABUJAR SHARDUL SAYYED	P	P	P
33	ADITYA RAJESH KAWALE	P	P	P
34	AKASH KUMAR SURESH KUMAR NAIR	P	P	P
35	AMAN SHARAD NAMPALLIWAR	P	P	P



NAGPUR INSTITUTE OF TECHNOLOGY

(Affiliated to RTM Nagpur University & Approved by AICTE New Delhi)

CAMPUS: 13/2, Mahurzari, Near Fetri, Katol Road, Nagpur-441501, India

Email Id : registrar@nit.edu.in Web : www.nit.edu.in Contact No. 09764974144

RTMNU College Code: 315

DTE Code: 4144

AICTE ID : 1-4830701

Department of Computer Science & Engineering

Session: 2023-24

36	AMAR GAJANAN PAIKRAO		P	
37	ANUJ SANJAY BOPCHE	P	P	P
38	ATHARVA VINOD HUSUKALE			
39	CHITRASEN VASANT RATHOD	P	P	P
40	DISHANK SURESH THAKRE		P	P
41	DURGESH YUVRAJ HIWARKAR	P	P	
42	HARSHAL DIPAKRAO DAUTPURE	P		
43	HITESH RAJKUMAR SHRIKHANDE		P	P
44	KSHITIJ RAMESH TELAMI	P	P	
45	KUNAL BABURAO TAGDE			
46	LOKESH PANDHARI DHARMIK			
47	MARSHAL PRAKASH ALONE	P	P	P
48	MD. ZAID MD. GALIB SHEIKH	P	P	P
49	MOHAK PRASHANT NANDESHWAR			
50	NAGESH VITTHAL LONDHE	P	P	
51	NAVIN RAJESH MANKAR		P	
52	NIHANT MANGESH THORKAR	P	P	P
53	PRIYANSHU SHAILESH DURATKAR		P	P
54	RISHIKESH AJAY WAIGAONKAR	P	P	P
55	RITESH PRASHANT KARPE	P	P	P
56	RUDRA MADHAVRAO DESHMUKH	P	P	P
57	RUSHIKESH MANISH JOSHI	P	P	P
58	SAMYAK YOGENDRA GAIKWAD	P	P	P
59	SANGMESHWAR GOPALREDDY MUSKAWAD	P	P	P
60	SUJAL ANAND ZADE		P	
61	SUJAL MANOHAR INGALE	P	P	P
62	SURAJ RAMRAO BHUJADE			
63	TEJAS SHIVAJI BIRHADE			
64	TUSHAR GAJANAN CHAKOLE	P	P	P
65	VEDANT SHAMLAL KAWALE	P	P	P
66	VIVEK RAJENDRA MESHARAM			
67	YASH SURESH LANDE	P	P	P
68	Shubham Nagorao Biradar	P	P	P
69	Pradip Govind Rathod	P	P	P
70	Vedant Santosh Pingalkur	P	P	P
71	Aditya Radheshyam Moon	P	P	P



NAGPUR INSTITUTE OF TECHNOLOGY

(Affiliated to RTM Nagpur University & Approved by AICTE New Delhi)

CAMPUS: 13/2, Mahurzari, Near Fetri, Katol Road, Nagpur-441501, India

Email Id : registrar@nit.edu.in Web : www.nit.edu.in Contact No. 09764974144

RTMNU College Code: 315

DTE Code: 4144

AICTE ID : 1-4830701

Department of Computer Science & Engineering

Session: 2023-24

72	Geeta Tanaji Thete			
73	Himanshu Vijay Bombarde		P	
74	Samiksha Jaikumar Jambulkar		P	P
75	Sumit Prashant Umbarkar	P		
76	Vaishnavi Sanjay Madavi	P	P	P
77	Gauri vilas Girsawle	P	P	P
78	Pratham Chandansingh Pawar	P	P	P
79	Vaibhav Madhukar Malkar		P	P

A. Gahankari
Prof. A. Gahankari

Event Coordinator

Dr. Shrikant Zade
Dr. Shrikant Zade

Head, CSE Deptt.
H.O.D.

Computer Science & Engineering Dept.
Nagpur Institute of Technology
Nagpur.

Nagpur Institute of Technology



NAGPUR INSTITUTE OF TECHNOLOGY

(Affiliated to RTM Nagpur University & Approved by AICTE New Delhi)

CAMPUS: 13/2, Mahurzari, Near Fetri, Katol Road, Nagpur-441501, India

Email Id : registrar@nit.edu.in Web : www.nit.edu.in Contact No. 09764974144

RTMNU College Code: 315

DTE Code: 4144

AICTE ID : 1-4830701

Department of Information Technology

Notice/Circular

Date: 26/02/2024

All the students of Information Technology are hereby informed that the Department of Information Technology is organising, the **2 day's Workshop on Current Trend in "IOT & Network Security"** on 29th Feb & 1st March 2024 at 11.30 a.m. The students of second year, third year and final year of information technology should attend and actively participate in the event Computer Lab, 3rd Floor A-Wing.

Coordinator
Prof. Monika Walde

Dr. M. Makesar
HoD, Information Technology

Copy To:

- 1) The Principal, NIT, Nagpur
- 2) The Dean(Academics), NIT, Nagpur

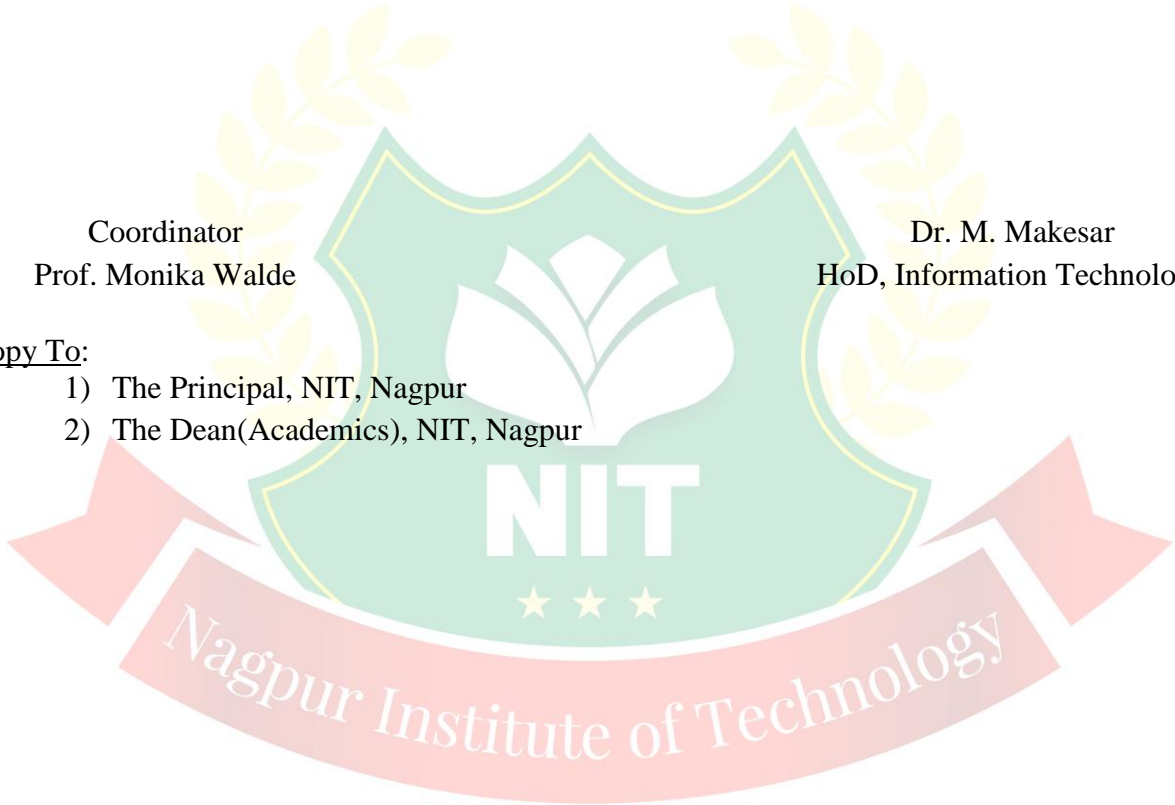



NAGPUR INSTITUTE OF TECHNOLOGY

(Affiliated to RTM Nagpur University & Approved by AICTE New Delhi)

CAMPUS: 13/2, Mahurzari, Near Fetri, Katol Road, Nagpur-441501, India

Email Id : registrar@nit.edu.in Web : www.nit.edu.in Contact No. 09764974144

RTMNU College Code: 315

DTE Code: 4144

AICTE ID : 1-4830701

Department of Information Technology

Date: 02/03/2024

Activity Report

Session	:	2023-2024
In association with	:	IIC/III Cell/ED Cell/FAME/ISHRAE
Program Type	:	Workshop
Date & duration	:	29/02/2024 & 01/03/2024 from 11:30 AM
Mode of delivery	:	Offline
Title	:	2 day's Workshop on Current Trend in "IOT & Network Security"
Name of Expert with Designation	:	PM Wasu Director ,CMS IT Services Pvt Ltd. Nagpur
Organization	:	CMS IT Services Pvt Ltd. Nagpur
Participants	:	Student:60 Faculty:09 External:-1
Objective of program	:	To sensitize students about the importance of standards in improving quality of life.
Coordinated by	:	Prof. Monika Walde

Event Details:

The Department Of Information Technology of Nagpur Institute of Technology organized **2 day's Workshop on Current Trend in "IOT & Network Security"** for the students of 3rd & 4th year.

Prof. Monika Walde gave the introductory remarks. A total of 60 Students participated from the 3rd-IV Sem & 4th-VI Sem Sem of Information Technology Dept. During the session, workshop started with the introduction of IOT network & security and he implemented the networking of IOT Using the CISCO App. He performed a demonstration with the students.

At the Concluding Dr. M. M.Makesar Appreciated the event that the session was very helpful for the students to help for the future. Prof. Monika Walde works hard for the success of the event. Program Proceeding was handled by Ms. Diya Madhne, a student of 2nd year.

Coordinator
Prof. Monika Walde

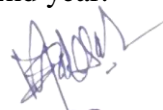
H.O.D.
Dr. M. Makesar
Information Technology Dept.
Nagpur Institute of Technology
HoD, Information Technology



NAGPUR INSTITUTE OF TECHNOLOGY

(Affiliated to RTM Nagpur University & Approved by AICTE New Delhi)

CAMPUS: 13/2, Mahurzari, Near Fetri, Katol Road, Nagpur-441501, India

Email Id : registrar@nit.edu.in Web : www.nit.edu.in Contact No. 09764974144

RTMNU College Code: 315

DTE Code: 4144

AICTE ID : 1-4830701

Department of Information Technology

Glimpses Of the Event:



Coordinator
Prof. Monika Walde

H.O.D.
Dr. M. Magesar
HoD, Information Technology



NAGPUR INSTITUTE OF TECHNOLOGY

(Affiliated to RTM Nagpur University & Approved by AICTE New Delhi)

CAMPUS: 13/2, Mahurzari, Near Fetri, Katol Road, Nagpur-441501, India

Email Id : registrar@nit.edu.in Web : www.nit.edu.in Contact No. 09764974144

RTMNU College Code: 315

DTE Code: 4144

AICTE ID : 1-4830701

Department of Information Technology

List of present students from 3rd year

Name Of Student	Status	Name Of Student	Status
Achal Rameshwar Wadhai	P	Kushal Ramesh Borkar	
Aman Dilipkumar Bangayya	P	Mayuri Vijay Balod	P
Amit Shishupal Masram	P	Mohammad Khalisd	P
Amol Purushottam Ninave	P	Monalisha Lekchand Meshram	P
Aniket Bhimraoji Tambuskar		Nandini Sudhir Deshmukh	P
Aniket Ganesh Balapure	P	Nayan Gangadhar Wagdarkar	P
Ankita Raju Nimje	P	Nidhi Rajesh Gajimwar	P
Ankur Satish Bansod	P	Om Ramesh Deshmukh	P
Arti Rustam Misal	P	Pallavi Anil Sharma	P
Ashlesha Dharpal Patil		Pallavi Krushnaji Chaple	
Ashmi Gautam Dahiwal	P	Prachi Gajanan Basle	P
Atul Gosai Rane		Prajwal Devidas Narnaware	P
Bhawna Anil Bhojar	P	Prasad Suresh Rao Nimje	
Bhuvan Gajanan Sontakke	P	Pratiksha Sanjay Girade	P
Chaitanya Rajendra Mahalle	P	Pravin Uttam Kumar Petkar	P
Changdeo Manoj Kale	P	Pritam Ravindra Awari	
Chetan Shivaji Kuyate		Prutha Pratik Sakhare	P
Deep Rajendra Wankhede	P	Ratnadeep Waman Mate	P
Deepkumar Prabhakar Mahajan		Rushikesh Rajendra Mundane	P
Girish Sanjay Chate		Shreesh Bhardwaj	
Harish Rajendra Bhajikhaye	P	Shruti Arun Bangade	P
Harshad Ajayrao Nakshane		Shyamal Shailendra Dhabarde	P
Himani Santosh Wasnik	P	Siddhant Aniruddha Bodele	
Hrutiksha Sanjay Girade	P	Siya Vijay Agarkar	P
Isha Hemantkumar Walde	P	Sneha Manish Pathak	P
Kamakshi Raju Samarth		Snehal Shekhar Bombale	
Karan Vipin Raut	P	Sudhanshu Tulshiram Kawade	P
Kashish Arvind Bajirao	P	Sudhir Dnyaneshwar Dakhole	P
Khushboo Roshan Gondane	P	Suryansu Bhumeswar Akulkar	
Khushbu Ashok Bhiwgade		Vrushali Gunwantrao Zod	P
Khushi Dinesh Gupta	P	Yash Raju Jogi	P
Komal Dinesh Paunikar	P	Yash Sahebrao Golait	P
Krotik Dharmashil Dahotkar	P	Yashnil Puralal Jagneet	P
Kunal Bhumeswar Bhojar			

Coordinator
Prof. Monika Walde

Dr. M. Makesar
HoD, Information Technology Dept.
Nagpur Institute of Technology
Nagpur.



NAGPUR INSTITUTE OF TECHNOLOGY

(Affiliated to RTM Nagpur University & Approved by AICTE New Delhi)

CAMPUS: 13/2, Mahurzari, Near Fetri, Katol Road, Nagpur-441501, India

Email Id : registrar@nit.edu.in Web : www.nit.edu.in Contact No. 09764974144

RTMNU College Code: 315

DTE Code: 4144

AICTE ID : 1-4830701

Department of Information Technology

List of Present students from 4th year

Name Of Student	Status	Name Of Student	Status
Aanchal Pramod Vishwakarma		Payal Ashok Nikose	
Achal Krushnrao Badode		Payal Suresh Turkar	
Aditya Ratan Moreshiya		Pinal Rajpal Dhanvij	
Akanksha Manohar Masram		Piyush Ganesh Selotkar	P
Aniket Arun Janbandhu		Prajwal Ramesh Warokar	
Arpan Bisundeo Mandal		Prashik Vinod Dhabarde	
Ayush Rajendra Bhange	P	Prathmesh Khobragade	
Badal Niranjana Janbandhu		Pratiksha Ganesh Selokar	
Damini Anil Chaube	P	Pravin Bhimrao Pal	
Dhamshil Jivan Meshram		Ragini Shamrao Motankar	
Ekankshi Sanjiv Barekar	P	Rani Rajendra Dhanjode	P
Harshal Yadavrao Mirche		Ritik Anil Balvir	
Harshdip Bhagat		Riya Pijush Dey	
Janhavi Rajendra Yawale		Rohit Nandu Banot	
Janvi Baban Khobragade		Rushali Umesh Parse	
Kajal Babarao Dakhare		Rushika Shrikant Ambade	
Karan Madhukar Sahare		Rutuparna Nitin Barde	
Khushi Kishor Jain	P	Sakshi Krishna Ukey	
Komal Moreshwar Lanjewar		Sakshi Ramesh Sahare	
Kuldipak Indalji Meshram		Samiksha Ravindra Thakre	
Mayuri Gajanan Hood		Sanjana Banduji Shahare	
Milind Girish Mahajan	P	Shafiya Anam Khan	
Mitali Sudarshan Sahu	P	Shreya Ashok Kotangale	
Mohammad Ehtesham Abdul Mubin		Shreya Sanjay Kotamkar	
Nikhil Mahendra Ramteke		Sima Udaram Nikhade	
Nikita Manoj Wankhede		Sohail Israil Saide	
Nikita Narayan Lolekar		Spandan Vandeo Patil	
Nilesh Sanjayrao Bhise		Tanvi Sushil Nagrare	
Nishikant Shrimohan Chaware	P	Vaishnavi Rajesh Balne	
Oshin Sushil Paul		Vaishnavi Sachin Gandhewar	
Pallavi Chandramani Wasnik	P	Vina Dilip Pande	
Pallavi Mahadev Karemore		Vishakha Ganesh Dhawad	
Pavan Ravindra Mahalle	P	Sagar Dhote	

Coordinator
Prof. Monika Walde

Dr. M. Makesar
HoD, Information Technology
Nagpur Institute of Technology
Nagpur.



NAGPUR INSTITUTE OF TECHNOLOGY

(Affiliated to RTM Nagpur University & Approved by AICTE New Delhi)

CAMPUS : 13/2, Mahurzari, Near Fetri, Katol Road, Nagpur-441501, India

Email Id : registrar@nit.edu.in Web : www.nit.edu.in Contact No. 09764974144

RTMNU College Code: 315

DTE Code: 4144

AICTE ID : 1-4830701

Department of Mechanical Engineering

Date: 23/01/2024

NOTICE

All students of 6th & 8th semesters are informed that **Department of Mechanical Engineering** is organizing 02 Day Workshop on CNC Programming in association with MSME Technology Center- IGTR, Nagpur. All are informed to remain present on 01/02/2024 in CAD Lab.

Prof. D. M. Lade
Coordinator

Dr. V N Kalbande
HOD, ME.
Mechanical Engineering
Nagpur Institute of Technology, Nagpur

Copy To:

- HOD, ME
- Class Incharge 6 & 8 Semester respectively.



NAGPUR INSTITUTE OF TECHNOLOGY

(Affiliated to RTM Nagpur University & Approved by AICTE New Delhi)

CAMPUS : 13/2, Mahurzari, Near Fetri, Katol Road, Nagpur-441501, India

Email Id : registrar@nit.edu.in Web : www.nit.edu.in Contact No. 09764974144

RTMNU College Code: 315

DTE Code: 4144

AICTE ID : 1-4830701

Department of Mechanical Engineering

Date: 03/02/2024

Workshop Report

Session	:	2023-2024
Program Type	:	Workshop
Date & duration	:	01/02/2024 To 02/02/2024
Mode of delivery	:	Offline
Title	:	02 Day Workshop on CNC Programming
Name of Expert	:	Mr. Shubham Yadav & Mr. Akshay Magarde Trainer from
Organization	:	Indo German Tool Room, Nagpur.
Participants	:	Student: 27 (3 rd & 4 th Year)
Objective of program	:	To introduce the Design Software
Coordinated by	:	Prof. G. P. Dhalwar

Event Details:

Mechanical Engineering Department organised 2 Day Workshop on CNC Programming in association with MSME Technology Center- IGTR, Nagpur. Resource persons: Mr. Shubham Yadav & Mr. Akshay Magarde Trainer from Indo German Tool Room, Nagpur. Opening remark was delivered by Dr. A.Y. Deshmukh, Principal NIT. Dr. V. N. Kalbande shared the importance of Workshop. The program was coordinated by Prof. G. P. Dhalwar and Prof.R. A. Deshmukh.

Glimpses of Activity :



Day 01



Day 02

DM Lade

Prof. D. M. Lade
Coordinator

Dr. V N Kalbande

Dr. V N Kalbande
HOD, ME.
Mechanical Engineering
Nagpur Institute of Technology, Nagpur



NAGPUR INSTITUTE OF TECHNOLOGY

(Affiliated to RTM Nagpur University & Approved by AICTE New Delhi)

CAMPUS : 13/2, Mahurzari, Near Fetri, Katol Road, Nagpur-441501, India

Email Id : registrar@nit.edu.in Web : www.nit.edu.in Contact No. 09764974144

RTMNU College Code: 315

DTE Code: 4144

AICTE ID : 1-4830701

Department of Mechanical Engineering

Title : 02 Day Workshop on CNC Programming

VI TH SEM - ROLL LIST SESSION : 2023-24

Roll No.	Students Name	ATTENDANCE	Roll No.	Students Name	ATTENDANCE
301	Astha Chintaman Bhalerao		19	Pavan Mulchand Patil	
302	Durva Kothiram Pelane		20	Praful Gokul Shengaye	
303	Khushi Sunil Gour	P	21	Prashnajit Vinod Sakharkar	P
304	Laxmi Ramesh Thakur		22	Prathamesh Kamal Shahu	
305	Nagkanya M. Gaikwad		23	Preshit Surendra Dhabarde	
306	Prajakta Bandu Gedam		24	Raj Govind Humne	
307	Vaishnavi Anil Gujare		25	Rizwan Tabarak Ansari	
308	Abhay Sharad Gedam		26	Sagar Dilip Sahare	
309	Akshay Nilkanth Dandekar		27	Sahil Satendra Godbole	
310	Ankush Ashok Baheshwar		28	Saurabh Balu Gudhe	
311	Ayaz Kalim Sheikh	P	29	Shubham Ranjit Bawane	P
312	Bhairav Manoharrao Helonde		30	Sujal Kamlesh Gajbhiye	
313	Bhavesht Sanjay Petkar		31	Suraj Chandrashekhar Mouje	P
314	Dishant Krushanji Lokhande		32	Utkarsh Shivshankar Dhore	
316	Harshal Sanjay Ganar	P	33	Utkarsh Umesh Ramteke	
317	Kalash Babarao Bansod		34	NIKHIL AMBADAS KOTJAWALE	P
318	Manthan Gopal Thambuskar		35	Vishal Satyabhan Chaudhari	
319	Mithilesh Hukumchand Patle	P	36	PRATIK C. PATIL	

DM Lade

Prof. D. M. Lade
Coordinator

Dr. V N Kalbande

Dr. V N Kalbande

HOD, ME.

Mechanical Engineering
Nagpur Institute of Technology, Nagpur



NAGPUR INSTITUTE OF TECHNOLOGY

(Affiliated to RTM Nagpur University & Approved by AICTE New Delhi)

CAMPUS : 13/2, Mahurzari, Near Fetri, Katol Road, Nagpur-441501, India

Email Id : registrar@nit.edu.in Web : www.nit.edu.in Contact No. 09764974144

RTMNU College Code: 315

DTE Code: 4144

AICTE ID : 1-4830701

Department of Mechanical Engineering

Title : 02 Day Workshop on CNC Programming

VIII TH SEM ROLL LIST

Roll No.	Students Name	ATTENDANCE	Roll No.	Students Name	ATTENDANCE
401	Payal Krushnaji Lokhande		433	Mahesh Vinod Dhapke	
402	Pranali Ravindra Meshram	P	435	Piyush Bhagwat Tadose	
403	Pratiksha Dinesh Manwatkar		436	Piyush Mahadeo Nikode	P
404	Priyanka Vinayak Tumlam		437	Piyush Umesh Puri	P
405	Rajshi Anklesh Indurkar	P	438	Prajwal Nakade	
406	Sagar Nepal Chamlate		439	Prajwal V. Bawane	P
407	Sanskruiti S.Chokhandre	P	440	Rahul Kanhiyalal Sahani	
408	Shravani Dinesh Kadu		441	Rishabh Vidhyadhar Chikhale	P
409	Tusharika Manohar Mahalle	P	442	Rishabh Yadkaran Sakhare	
410	Abhilash Bharat Murar	P	443	Rohit Manohar Shendre	P
413	Aditya Jagannath Kelwade		444	Rohit Mukunda Kathane	
414	Aditya Vijayrao Boratkar	P	446	Sahil Bagde	P
415	Akash Kundlik Mene		447	Sahil Fulzele	
416	Akash Maroti Shendre	P	449	Santvan Rajesh Jagtap	
417	Aman Ansari	P	450	Satyendra Sadashiv Upwanshi	
418	Amar Adnyan Pendram		451	Saurabh Ganesh Hasbe	
419	Amin Mammusabu Pathan		452	Saurabh Marotrao Mohankar	
420	Aniruddh Laxman Sonkamble	P	453	Saurabh Omkar Kaurati	
421	Aniruddha Sonekar		454	Savin Surjuse	
422	Ankush Ganesh Chaudhary		455	Sumit Bhawarkar	
424	Anush Uttamkumar Petkar	P	456	Sumit Kumar Yadav	
425	Ayush Nandu Ganvir		457	Swapnil Ashok Khonde	
427	Ganesh Sudam Raut	P	458	Ujwal Satish Lakhde	
428	Gaurav Rajeram Diwate		459	Vaibhav Vasudev Thakre	
429	Harshal Shravan Zade	P	460	Vinay Arkilla	
430	Ishant Harish Lokhande		461	Vivek Ashok Wankhede	
431	Jitesh Munjewar	P	462	Yash Athod	
432	Kunal Madhukar Wasnik		463	Sagar Dilip Shingade	

Prof. D. M. Lade
Coordinator

Dr. V N Kalbande
HOD, ME.

Mechanical Engineering
Nagpur Institute of Technology, Nagpur

NAGPUR INSTITUTE OF TECHNOLOGY

(Affiliated to RTM Nagpur University & Approved by AICTE New Delhi)

CAMPUS : 13/2, Mahurzari, Near Fetri, Katol Road, Nagpur-441501, India

Email Id : registrar@nit.edu.in Web : www.nit.edu.in Contact No. 09764974144

RTMNU College Code: 315

DTE Code: 4144

AICTE ID : 1-4830701

Department of Electrical Engineering
Session 2023-24

Notice

Date: 23/03/2024

All the Students of Electrical Engineering department is hereby informed that workshop by, **Dr.Sanjay Bodkhe, Professor and Head (EE), RCoEM, Nagpur** on the topic “**2 days Workshop on Simulation of Electrical Machine by using MATLAB**” is arranged on date 22/09/2023 to 23/09/2023. All students should come in the college uniform.



Prof. S. D. Khadse
Coordinator

Dr. J. G. Chaudhari
HoD, Electrical

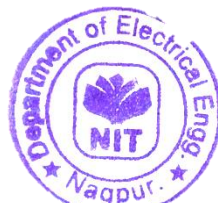

H. O. D.
Department of Electrical Engg.
Nagpur Institute of Technology



NAGPUR INSTITUTE OF TECHNOLOGY

(Affiliated to RTM Nagpur University & Approved by AICTE New Delhi)

CAMPUS : 13/2, Mahurzari, Near Fetri, Katol Road, Nagpur-441501, India

Email Id : registrar@nit.edu.in Web : www.nit.edu.in Contact No. 09764974144

RTMNU College Code: 315

DTE Code: 4144

AICTE ID : 1-4830701

Department of Electrical Engineering Session 2023-24

Activity Report

Date: 23//09/2023

Session	:	2023-2024
In association with	:	Feeder Forum/ IE(I) Student Chapter / Internal Quality Assurance cell (IQAC)
Program Type	:	Workshop
Date & duration	:	22/09/2023 - 23/09/2023
Mode of delivery	:	Offline
Title	:	Workshop on Simulation of Electrical Machine by using MATLAB
Name of Expert with Designation	:	Dr.Sanjay Bodkhe, Professor and Head (EE), RCoEM, Nagpur
Participants	:	Student: 38 Faculty: 04 External:00
Objective of program	:	To Enhance a skill among students along with the theoretical part to fill the gap between academic and industry.

Introduction:

Department of Electrical Engineering, Nagpur Institute of Technology, Nagpur organized a Two Days workshop on : “Simulation of Electrical Machine by using MATLAB” Jointly Organized by IE (I) Student Chapter of Department of Electrical Engineering. As an Internal Quality Assurance cell (IQAC) Initiative under the banner of Feeder Forum on Date 22/09/2023 - 23/09/2023. The Expert Dr.Sanjay Bodkhe, Professor and Head (EE),RCoEM, Nagpur had delivered the Session considering future aspects of Simulation of Electrical Machine by using MATLAB.

Inaugural function of workshop with the Hands of Respected Dr.Sanjay Bodkhe, Professor and Head (EE),RCoEM

Day-I: All 38 participants gathered at the Electrical Machine lab, Expert Dr.Sanjay Bodkhe, Professor and Head (EE),RCoEM, Nagpur guided participants on Simulation of Electrical Machine by using MATLAB.

Day-II: Students simulate machines using MATLAB software.

NAGPUR INSTITUTE OF TECHNOLOGY

(Affiliated to RTM Nagpur University & Approved by AICTE New Delhi)

CAMPUS : 13/2, Mahurzari, Near Fetri, Katol Road, Nagpur-441501, India

Email Id : registrar@nit.edu.in Web : www.nit.edu.in Contact No. 09764974144

RTMNU College Code: 315

DTE Code: 4144

AICTE ID : 1-4830701

Department of Electrical Engineering Session 2023-24



Outcome of Seminar :

Students get to know theoretical and Practical part of Simulation of Electrical Machine by using MATLAB to fill the gap between academic and industry

Conclusion:

Students get knowledge about different tools of Simulation of Electrical Machine by using MATLAB Theoretically and Practically.

Acknowledgment:

- 1) On behalf of the Electrical Engineering Department we sincerely thank Dr. Sanjay Bodkhe, Professor and Head(EE),RCoEM, Nagpur for accepting our invitation and delivering a Workshop on “Simulation of Electrical Machine by using MATLAB” to our students.
- 2) Our deep sense of gratitude to Dr. Amol Deshmukh, Principal, N.I.T. for providing support in organizing the Seminar .

Prof. S. D. Khadse
Coordinator

Dr. J. G. Chaudhari
HoD, Electrical

NAGPUR INSTITUTE OF TECHNOLOGY

(Affiliated to RTM Nagpur University & Approved by AICTE New Delhi)

CAMPUS : 13/2, Mahurzari, Near Fetri, Katol Road, Nagpur-441501, India

Email Id : registrar@nit.edu.in Web : www.nit.edu.in Contact No. 09764974144

RTMNU College Code: 315

DTE Code: 4144

AICTE ID : 1-4830701

Department of Electrical Engineering Session 2023-24

Activity Attendance Sheet

Topic: - 2 days Workshop on Simulation of Electrical Machine by using MATLAB

Expert Name & Designation: Dr.Sanjay Bodkhe, Professor and Head (EE),

Organization: - RCoEM, Nagpur

Year: - Third Year

Roll. No.	Name of Student	DAY 1	DAY 2
EE_301	Ankita Manohar Bhubade	P	P
EE_302	Arpita Mahesh Kumre	P	P
EE_303	Ashwini Suresh Meshram	P	P
EE_304	Dipika Batulal Nagpure	P	P
EE_306	Greny Pravin Choudhari	P	P
EE_307	Hina Wasnik	P	P
EE_308	Kishori Anil Wasade	P	P
EE_309	Krutika Ratnakar Gadge	P	
EE_310	Lalita Manoj Narnaware	P	P
EE_312	Pallavi Fuldas Janbandhu	P	P
EE_313	Pallavi Rajkumar Gajbhiye		P
EE_316	Pritee Manoj Tilgame	P	P
EE_317	Priti Ramesh Patil	P	P
EE_318	Puja Guniram Pandharam	P	P
EE_319	Punam Madhav Dhengare	P	P
EE_320	Punam Rajkumar Kosme		P
EE_321	Ragini Ranjit Bawane	P	P
EE_322	Sandhya Sanjay Meshram	P	P
EE_323	Sapna Natthu Gondule	P	

NAGPUR INSTITUTE OF TECHNOLOGY

(Affiliated to RTM Nagpur University & Approved by AICTE New Delhi)

CAMPUS : 13/2, Mahurzari, Near Fetri, Katol Road, Nagpur-441501, India

Email Id : registrar@nit.edu.in Web : www.nit.edu.in Contact No. 09764974144

RTMNU College Code: 315

DTE Code: 4144

AICTE ID : 1-4830701

Department of Electrical Engineering Session 2023-24

EE_324	Shivani Shankar Lamtile		P
EE_327	Yeshmita Gajanan Bawane	P	P
EE_328	Aditya Prakash Gode	P	P
EE_329	Ankit Nagoba Ramteke	P	P
EE_331	Aryan Nitesh Meshram	P	P
EE_332	Ayush Sanjayrao Dahiwade	P	P
EE_333	Bhushan Santosh Kharpuriya	P	
EE_334	Chinmay Manoharrao Rewaskar	P	P
EE_336	Harshal Babanrao Sarode	P	P
EE_337	Hrushabh Sahebrao Dupare	P	P
EE_338	Kunal Rashtrapal Badole	P	P
EE_339	Mithilesh Sanjay Tagde	P	P
EE_341	Prajwal Bhagwatrao Dhopre		P
EE_343	Prathmesh Manohar Gaikwad	P	P
EE_344	Pravin Manojkumar Rahangdale	P	P
EE_345	Sanchit Dilip Pantawane	P	P
EE_346	Shahanawaz Shafique Sheikh	P	
EE_347	Sushant Pradip Gawai	P	P
EE_348	Tanmay Dhiraj Lanjewar		P



Prof. S. D. Khadse
Coordinator



Dr. J. G. Chaudhari
HoD, Electrical



NAGPUR INSTITUTE OF TECHNOLOGY

(Affiliated to RTM Nagpur University & Approved by AICTE New Delhi)

CAMPUS: 13/2, Mahurzari, Near Fetri, Katol Road, Nagpur-441501, India

Email Id : registrar@nit.edu.in Web : www.nit.edu.in Contact No. 09764974144

RTMNU College Code: 315

DTE Code: 4144

AICTE ID : 1-4830701

Department of Information Technology

Notice/Circular

Date: 01/08/2023

All the students of Information Technology are hereby informed that the Department of Information Technology is organising, the **2 days Workshop on Latest Trend in “Website Designing”** on 04th & 05th August 2023 at 11.30 a.m. The students of second year, third year and final year of information technology should attend and actively participate in the event Computer Lab, 3rd Floor A-Wing

Coordinator
Dr. M. Makesar

Dr. M. Makesar
HOD, Information Technology Dept.
Nagpur Institute of Technology
Nagpur.

Copy To:

- 1) The Principal, NIT, Nagpur
- 2) The Dean(Academics), NIT, Nagpur

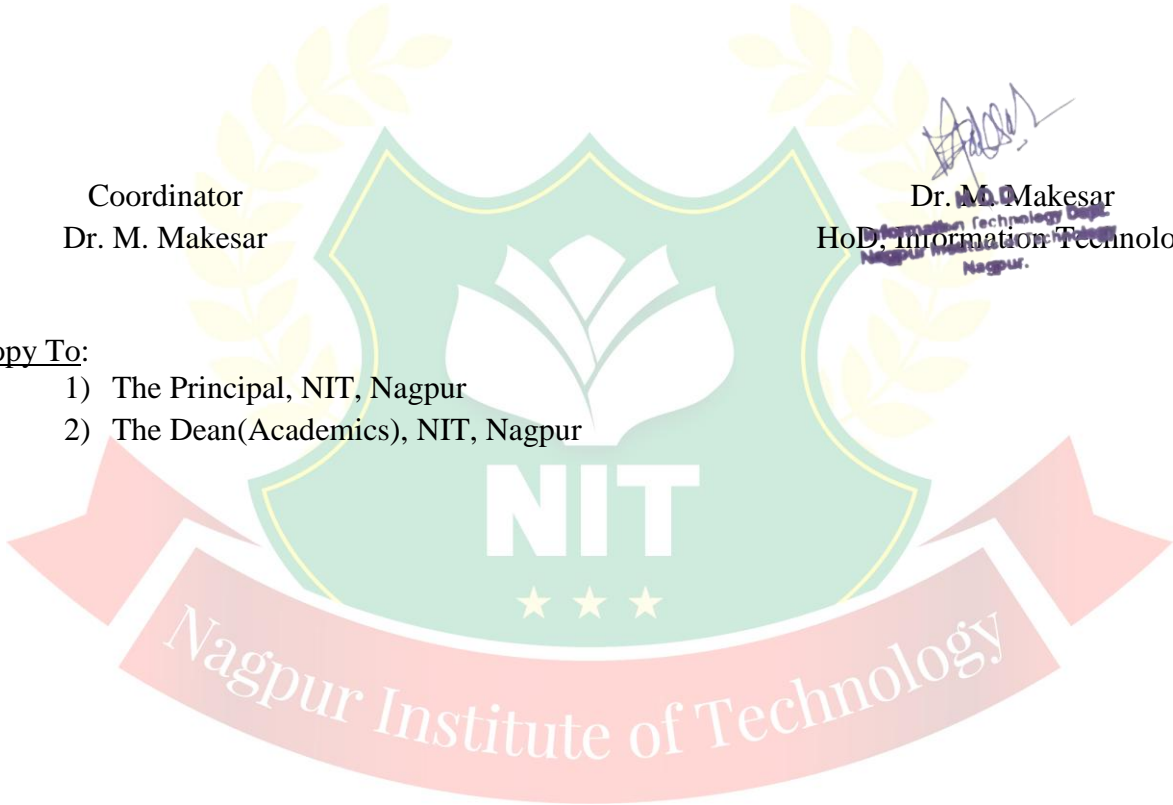



NAGPUR INSTITUTE OF TECHNOLOGY

(Affiliated to RTM Nagpur University & Approved by AICTE New Delhi)

CAMPUS: 13/2, Mahurzari, Near Fetri, Katol Road, Nagpur-441501, India

Email Id : registrar@nit.edu.in Web : www.nit.edu.in Contact No. 09764974144

RTMNU College Code: 315

DTE Code: 4144

AICTE ID : 1-4830701

Department of Information Technology

Date: 07/08/2023

Activity Report

Session	:	2023-2024
In association with	:	IIC/III Cell/ED Cell/FAME/ISHRAE
Program Type	:	Seminar
Date & duration	:	04/08/2023 & 05/08/2023 from 11.30 am
Mode of delivery	:	Offline
Title	:	2 days Workshop on Latest Trend in “Website Designing”
Name of Expert with Designation	:	Prof.S.G.Gadhve, St. Vincent Pallotti College of Engineering & Technology.
Organization	:	St. Vincent Pallotti College of Engineering & Technology.
Participants	:	Student: 90 Faculty: 09 External:- 1
Objective of program	:	To sensitize students about the importance of standards in improving quality of life.
Coordinated by	:	Dr. M.S.Makesar

Event Details:

Details of Event:

The Department of Information Technology of Nagpur Institute of Technology organized **2 days Workshop on Latest Trend in “Website Designing”** for the students of 3rd & 4th year.

Dr. M. Makesar gave the introductory remarks. Total 90 Students participated from 3rd-VSem, & Final-VIISem of the Information Technology Dept. During the session, Expert Speaker started with an introduction to website designing, HTML, CSS. This was very helpful for the students to help in the future. Dr. M. Makesar sir work hard for the success of the event. Program Proceeding was handled by Ms Nidhi Gajimwar student of 3rd year.

Coordinator
Dr. M. Makesar

Dr. M. Makesar
HoD, Information Technology Dept.
Nagpur Institute of Technology
Nagpur.



NAGPUR INSTITUTE OF TECHNOLOGY

(Affiliated to RTM Nagpur University & Approved by AICTE New Delhi)

CAMPUS: 13/2, Mahurzari, Near Fetri, Katol Road, Nagpur-441501, India

Email Id : registrar@nit.edu.in Web : www.nit.edu.in Contact No. 09764974144

RTMNU College Code: 315

DTE Code: 4144

AICTE ID : 1-4830701

Department of Information Technology

Glimpses of the Event:



Coordinator
Dr. M. Makesar

H.O.D.
Information Technology Dept.
Nagpur Institute of Technology
Nagpur.
HoD, Information Technology



NAGPUR INSTITUTE OF TECHNOLOGY

(Affiliated to RTM Nagpur University & Approved by AICTE New Delhi)

CAMPUS: 13/2, Mahurzari, Near Fetri, Katol Road, Nagpur-441501, India

Email Id : registrar@nit.edu.in Web : www.nit.edu.in Contact No. 09764974144

RTMNU College Code: 315

DTE Code: 4144

AICTE ID : 1-4830701

Department of Information Technology

List of present students from 3rd year

Name Of Student	Status	Name Of Student	Status
Achal Rameshwar Wadhai	P	Kushal Ramesh Borkar	P
Aman Dilipkumar Bangayya	P	Mayuri Vijay Balod	P
Amit Shishupal Masram	P	Mohammad Khalisd	P
Amol Purushottam Ninave	P	Monalisha Lekchand Meshram	P
Aniket Bhimraoji Tambuskar		Nandini Sudhir Deshmukh	P
Aniket Ganesh Balapure	P	Nayan Gangadhar Wagdarkar	P
Ankita Raju Nimje	P	Nidhi Rajesh Gajimwar	P
Ankur Satish Bansod	P	Om Ramesh Deshmukh	P
Arti Rustam Misal	P	Pallavi Anil Sharma	P
Ashlesha Dharpal Patil		Pallavi Krushnaji Chaple	
Ashmi Gautam Dahiwal	P	Prachi Gajanan Basle	P
Atul Gosai Rane		Prajwal Devidas Narnaware	P
Bhawna Anil Bhojar	P	Prasad Suresh Rao Nimje	
Bhuvan Gajanan Sontakke	P	Pratiksha Sanjay Girade	P
Chaitanya Rajendra Mahalle	P	Pravin Uttam Kumar Petkar	P
Changdeo Manoj Kale	P	Pritam Ravindra Awari	
Chetan Shivaji Kuyate		Prutha Pratik Sakhare	P
Deep Rajendra Wankhede	P	Ratnadeep Waman Mate	P
Deepkumar Prabhakar Mahajan	P	Rushikesh Rajendra Mundane	P
Girish Sanjay Chate		Shreesh Bhardwaj	
Harish Rajendra Bhajikhaye	P	Shruti Arun Bangade	P
Harshad Ajayrao Nakshane		Shyamal Shailendra Dhabarde	P
Himani Santosh Wasnik	P	Siddhant Aniruddha Bodele	
Hrutiksha Sanjay Girade	P	Siya Vijay Agarkar	P
Isha Hemantkumar Walde	P	Sneha Manish Pathak	P
Kamakshi Raju Samarth		Snehal Shekhar Bombale	
Karan Vipin Raut	P	Sudhanshu Tulshiram Kawade	P
Kashish Arvind Bajirao	P	Sudhir Dnyaneshwar Dakhole	P
Khushboo Roshan Gondane	P	Suryansu Bhumeswar Akulkar	
Khushbu Ashok Bhiwgade		Vrushali Gunwantrao Zod	P
Khushi Dinesh Gupta	P	Yash Raju Jogi	P
Komal Dinesh Paunekar	P	Yash Sahebrao Golait	P
Krotik Dharmashil Dahotkar	P	Yashnil Puralal Jagneet	P
Kunal Bhumeswar Bhojar			

Coordinator
Prof. Monika Walde

Dr. M. Mahesha
HoD, Information Technology



NAGPUR INSTITUTE OF TECHNOLOGY

(Affiliated to RTM Nagpur University & Approved by AICTE New Delhi)

CAMPUS: 13/2, Mahurzari, Near Fetri, Katol Road, Nagpur-441501, India

Email Id : registrar@nit.edu.in Web : www.nit.edu.in Contact No. 09764974144

RTMNU College Code: 315

DTE Code: 4144

AICTE ID : 1-4830701

Department of Information Technology

List of Present students from 4th year

Name Of Student	Status	Name Of Student	Status
Aanchal Pramod Vishwakarma	P	Payal Ashok Nikose	
Achal Krushnrao Badode	P	Payal Suresh Turkar	P
Aditya Ratan Moreshiya		Pinal Rajpal Dhanvij	
Akanksha Manohar Masram	P	Piyush Ganesh Selotkar	P
Aniket Arun Janbandhu		Prajwal Ramesh Warokar	
Arpan Bisunde Mandal	P	Prashik Vinod Dhabarde	P
Ayush Rajendra Bhange	P	Prathmesh Khobragade	
Badal Niranjana Janbandhu		Pratiksha Ganesh Selokar	P
Damini Anil Chaube	P	Pravin Bhimrao Pal	
Dhamshil Jivan Meshram		Ragini Shamrao Motankar	P
Ekankshi Sanjiv Barekar	P	Rani Rajendra Dhanjode	P
Harshal Yadavrao Mirche	P	Ritik Anil Balvir	
Harshdip Bhagat	P	Riya Pijush Dey	P
Janhavi Rajendra Yawale		Rohit Nandu Banot	
Janvi Baban Khobragade	P	Rushali Umesh Parse	P
Kajal Babarao Dakhare	P	Rushika Shrikant Ambade	
Karan Madhukar Sahare		Rutuparna Nitin Barde	P
Khushi Kishor Jain	P	Sakshi Krishna Ukey	P
Komal Moreshwar Lanjewar		Sakshi Ramesh Sahare	P
Kuldipak Indalji Meshram	P	Samiksha Ravindra Thakre	P
Mayuri Gajanan Hood		Sanjana Banduji Shahare	P
Milind Girish Mahajan	P	Shafiya Anam Khan	
Mitali Sudarshan Sahu	P	Shreya Ashok Kotangale	P
Mohammad Ehtesham Abdul Mubin		Shreya Sanjay Kotamkar	
Nikhil Mahendra Ramteke		Sima Udaram Nikhade	P
Nikita Manoj Wankhede	P	Sohail Israil Saide	
Nikita Narayan Lolekar	P	Spandan Vandeo Patil	P
Nilesh Sanjayrao Bhise		Tanvi Sushil Nagrare	
Nishikant Shrimohan Chaware	P	Vaishnavi Rajesh Balne	P
Oshin Sushil Paul		Vaishnavi Sachin Gandhewar	P
Pallavi Chandramani Wasnik	P	Vina Dilip Pande	P
Pallavi Mahadev Karemore		Vishakha Ganesh Dhawad	P
Pavan Ravindra Mahalle	P	Sagar Dhote	

Coordinator
Prof. Monika Walde

Dr. M. Makasani
HoD, Information Technology



NAGPUR INSTITUTE OF TECHNOLOGY

(Affiliated to RTM Nagpur University & Approved by AICTE New Delhi)

CAMPUS : 13/2, Mahurzari, Near Fetri, Katol Road, Nagpur-441501, India

Email Id : registrar@nit.edu.in Web : www.nit.edu.in Contact No. 09764974144

RTMNU College Code: 315

DTE Code: 4144

AICTE ID : 1-4830701

Department of Civil Engineering Session :2023-24

Date: 07-10-2023

NOTICE

Department of civil Engineering organizing Two Day workshop on Stadd Pro in "Structural Design technology" for the students of Final Year. All are informed to be remain present on 10-10-2023 and 11-10-2023 in Civil Engineering Department.

Prof. Rohit Bhosle
Co-ordinator Seminar

Dr. Syed Zafar
HOD Civil Engg

Head of Department
Civil Engineering
Nagpur Institute of Technology
Nagpur

Copy To:

- 1) Principal
- 2) HOD CE
- 3) Class incharge 4th Year



NAGPUR INSTITUTE OF TECHNOLOGY

(Affiliated to RTM Nagpur University & Approved by AICTE New Delhi)

CAMPUS : 13/2, Mahurzari, Near Fetri, Katol Road, Nagpur-441501, India

Email Id : registrar@nit.edu.in Web : www.nit.edu.in Contact No. 09764974144

RTMNU College Code: 315

DTE Code: 4144

AICTE ID : 1-4830701

Department of Civil Engineering Session :2023-24

Date: 12-10-2023

Program Report

Session	:	2023-2024
In association with	:	Civil Engineering students Associations (CESA)
Program Type	:	Workshop
Date	:	10-10-2023 and 11-10-2023
Mode of delivery	:	Offline
Title	:	Two Day workshop on Stadd Pro in “Structural Design Technology”
Name of Expert with Designation	:	1. Mr. Swapnil Udapurkar, Center Head 2. Ms Priyanka kanojiya, Structural Design Engineer 3. Ms Bhagyashree Selore, Design Engineer
Organization	:	CADD Center Nagpur
Participants	:	Students: 55
Objective of program	:	To enhance designing skill using Stadd Pro
Coordinated by	:	Prof. Rohit Bhosle.

Event Details:

Civil Engineering Department of Nagpur Institute of Technology, Nagpur organized the Two Day workshop on Stadd Pro in “Structural Design technology” on the 10-10-2023 and 11-10-2023 under CESA. The event started with the welcoming of eminent guests Mr. Swapnil Udapurkar, Center Head, Ms Priyanka kanojiya, Structural Design Engineer and Ms Bhagyashree Selore, Design Engineer CADD Center Nagpur. Finally the session was ended by Prof. Rohit Bhosle with vote of thanks. The workshop was successfully coordinated by Prof. Rohit Bhosle and entire Civil Engineering department and also Civil Engineering team worked hard to make the program a grand success.



NAGPUR INSTITUTE OF TECHNOLOGY

(Affiliated to RTM Nagpur University & Approved by AICTE New Delhi)

CAMPUS : 13/2, Mahurzari, Near Fetri, Katol Road, Nagpur-441501, India

Email Id : registrar@nit.edu.in Web : www.nit.edu.in Contact No. 09764974144

RTMNU College Code: 315

DTE Code: 4144

AICTE ID : 1-4830701

Department of Civil Engineering
Session :2023-24

Glimpses of Activity :



Prof. Rohit Bhosle
Coordinator

Dr. Syed Zafar
HoD, Civil

Head of Department
Civil Engineering
Nagpur Institute of Technology
Nagpur



NAGPUR INSTITUTE OF TECHNOLOGY

(Affiliated to RTM Nagpur University & Approved by AICTE New Delhi)

CAMPUS : 13/2, Mahurzari, Near Fetri, Katol Road, Nagpur-441501, India

Email Id : registrar@nit.edu.in Web : www.nit.edu.in Contact No. 09764974144

RTMNU College Code: 315

DTE Code: 4144

AICTE ID : 1-4830701

Department of Civil Engineering Session :2023-24

CRN	Name of Student	ATT.	CRN	Name of Student	ATT.
401	Aarti Madhukarrao Wawre	P	435	Harsh Rajendra Dahat	P
402	Achal Bhojraj Dahat		436	Harshal Dashrath Bawane	P
403	Achal Gajanan Thakre	P	437	Jayash Prakash Shiwankar	P
404	Achal Sahebrao Sonole	P	438	Khilesh RadheTembhurne	P
405	Adita Devaji Bhujade	P	439	Manish Ashok Sakhare	P
406	Astha Dinanath Chapre	P	440	Manish Sunil Karkade	P
407	Bhagyashree Pravin Wanjari	P	441	Manthan Prakash Ghutke	P
408	Chetana Naresh Salam	P	442	Mohit Arvind Ambarte	P
409	Dhanshree Rajesh Dhakde	P	443	Om Sanjay Gunjkar	
410	Dileshwari Manohar Sewate	P	444	Omdeo Pundlika Dhudas	
411	Divya Pramod Nagrale	P	445	Palak Devendra Telang	
412	Jasmine Ramesh Masram	P	446	Palash Manoj Wasnik	P
413	Khushi Raju Mandalwar	P	447	Prajwal Uddhao Sahare	P
414	Neha Pandhari Dharmik	P	448	Prashant Jaygopal Bankar	
415	Pallavi Subhash Wadhankar		449	Prathmesh Vinod Sarnaik	P
416	Payal Pramod Rambhad	P	450	Pratik Tilkchand Gajbhiye	P
417	Prachi Dinesh Gedam	P	451	Rahul Bhailal Chauhan	P
418	Prajwal Dhanraj Gholase	P	452	Ritik Vijay Kolhe	P
419	Pranali Sheshrao Ghubde	P	453	Rohit Bhaskar Bakade	P
420	Pranjali Rajesh Suryawanshi	P	454	Sachin Gangadhar Chokhandre	P
421	Pratiksha Dipakrao Raut	P	455	Sahil Yograj Kowarte	P
422	Pratiksha Rajesh Rangari		456	Shubham P. Dharaskar	P
423	Priyanka Jitendra Meshram	P	457	Siddhan Sunil Somkuwar	
424	Roshani Dilip Ganvir	P	458	Siddhant Prakash Jadhav	P
425	Runal Rajendra Taksande	P	459	Tejas Sharad Tarar	
426	Sanyukta Rajesh Meshram	P	460	Vaibhav Ravindra Kawale	P
427	Sneha Vinayak Gajbhiye	P	461	Vijay Sanjay Bhalerao	P
428	Aishwarya Raju Khorgade		462	Vikas Ramkrushna Dhurve	P
429	Arjunsingh M. Maraskolhe	P	463	Viplav Narendra Meshram	P
430	Chetan P. Pandhare	P	464	Vishnu Anil Meshram	P
431	Darshan Liladhar Wandile	P	465	Vivek Santosh Suhagpure	
432	Deep Thamdeo Nandanwar		466	Yash Moreshwar Balpande	P
433	Devashish Niranjan Wanjari	P	467	Yash Sanjayrao Dahiwade	P

Prof. Rohit Bhosle
Coordinator

Dr. Syed Zafar
Head of Department
Civil Engineering
Nagpur Institute of Technology
Nagpur

NAGPUR INSTITUTE OF TECHNOLOGY



(Affiliated to RTM Nagpur University & Approved by AICTE New Delhi)

CAMPUS : 13/2, Mahurzari, Near Fetri, Katol Road, Nagpur-441501, India

Email Id : registrar@nit.edu.in Web : www.nit.edu.in Contact No. 09764974144

RTMNU College Code: 315

DTE Code: 4144

AICTE ID : 1-4830701

Department of Electrical Engineering Session 2023-24

Notice

Date: 23/03/2024

All the Students of Electrical Engineering department is hereby informed that workshop by, **Er. Akash Thakre, Electrical Design Engr Astral Informatic Pvt Ltd** on the topic “**2 days workshop on Drawing Software for Electrical Engineers**” is arranged on date 27/03/2024 to 28/03/2024. All students should come in the college uniform.

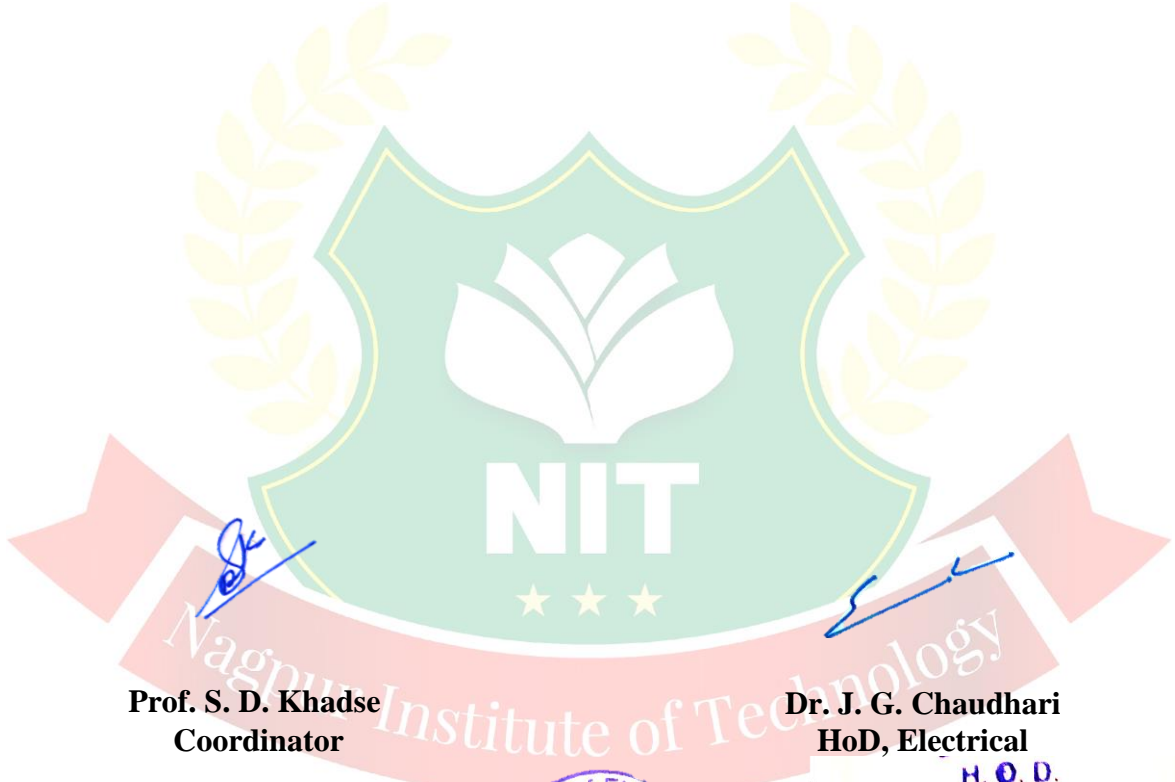

Prof. S. D. Khadse
Coordinator

Dr. J. G. Chaudhari
HoD, Electrical
H. O. D.

Department of Electrical Engg.
Nagpur Institute of Technology





NAGPUR INSTITUTE OF TECHNOLOGY

(Affiliated to RTM Nagpur University & Approved by AICTE New Delhi)

CAMPUS : 13/2, Mahurzari, Near Fetri, Katol Road, Nagpur-441501, India

Email Id : registrar@nit.edu.in Web : www.nit.edu.in Contact No. 09764974144

RTMNU College Code: 315

DTE Code: 4144

AICTE ID : 1-4830701

Department of Electrical Engineering Session 2023-24

Activity Report

Date: 28//03/2024

Session	:	2023-2024
In association with	:	Feeder Forum/ IE(I) Student Chapter / Internal Quality Assurance cell (IQAC)
Program Type	:	Workshop
Date & duration	:	27/03/2024 - 28/03/2024
Mode of delivery	:	Offline
Title	:	Drawing Software for Electrical Engineers
Name of Expert with Designation	:	Er. Akash Thakre, Electrical Design Engr Astral Informatic Pvt Ltd
Participants	:	Student: 32 Faculty: 04 External:00
Objective of program	:	To Enhance a skill among students along with the theoretical part to fill the gap between academic and industry.

Introduction:

Department of Electrical Engineering, Nagpur Institute of Technology, Nagpur organized a Two Days workshop on : “Drawing Software for Electrical Engineers” Jointly Organized by IE (I) Student Chapter of Department of Electrical Engineering & Astral Informatic Pvt Ltd. As an Internal Quality Assurance cell (IQAC) Initiative under the banner of Feeder Forum on Date 27/03/2024 - 28/03/2024. The Trainer Er. Akash Thakre Electrical Design Engineer Astral Informatic Pvt Ltd had delivered the Session considering future aspects of Drawing Software for Electrical Engineers as today’s era.

Inaugural function of workshop with the Hands of Respected HoD Dr. J. G. Chaudhari.

Day-I: All 32 participants gathered at the Computer lab. Electrical Engineering , Expert Er. Akash Thakre Electrical Design Engineer guid participant on Drawing Software for Electrical Engineer.

Day-II : Students performing various tasks given by the guide.



NAGPUR INSTITUTE OF TECHNOLOGY

(Affiliated to RTM Nagpur University & Approved by AICTE New Delhi)

CAMPUS : 13/2, Mahurzari, Near Fetri, Katol Road, Nagpur-441501, India

Email Id : registrar@nit.edu.in Web : www.nit.edu.in Contact No. 09764974144

RTMNU College Code: 315

DTE Code: 4144

AICTE ID : 1-4830701

Department of Electrical Engineering Session 2023-24



Outcome of Seminar :

Students get to know theoretical and Practical part of Drawing software in Electrical Engineering to fill the gap between academic and industry

Conclusion:

Students get knowledge about different tools of Drawing software in Electrical Engineering Theoretically and Practically.

Acknowledgment:

- 1) On behalf of the Electrical Engineering Department we sincerely thank Er. Akash A. Thakre, Electrical Design Engineer, Astral Informatics Pvt. Ltd, Nagpur for accepting our invitation and delivering a Workshop on “Drawing Softwares for Electrical Engineers” to our students from Curriculum, Research and Application point of view.
- 2) Our deep sense of gratitude to Dr. Amol Deshmukh, Principal, NIT, Nagpur for providing support in organizing the Seminar.

Prof. S. D. Khadse
Coordinator

Dr. J. G. Chaudhari
HoD, Electrical

H. O. D.

Department of Electrical Engg.
Nagpur Institute of Technology

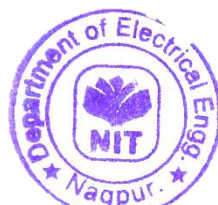



NAGPUR INSTITUTE OF TECHNOLOGY

(Affiliated to RTM Nagpur University & Approved by AICTE New Delhi)

CAMPUS : 13/2, Mahurzari, Near Fetri, Katol Road, Nagpur-441501, India

Email Id : registrar@nit.edu.in Web : www.nit.edu.in Contact No. 09764974144

RTMNU College Code: 315

DTE Code: 4144

AICTE ID : 1-4830701

Department of Electrical Engineering Session 2023-24

Date:-28//03/2024

Activity Attendance Sheet

Topic: - 2 days Workshop on Drawing Software for Electrical Engineers

Expert Name & Designation: Er. Akash Thakre, Electrical Design Engineer

Organization: - Astral Informatic Pvt Ltd

Year: - Final Year

Roll. No.	Name of Student	DAY 1 27/03/2024	DAY 2 28/03/2024
EE-401	Achal Kailash Sonekar	P	P
EE-402	Aishwarya Ghanshyam Alone	P	P
EE-405	Anuradha Subhash Mahalvanshi	P	P
EE-406	Arti Ashok Karnake	P	P
EE-409	Dhanashree Purushottam Judpe		P
EE-411	Dhanshree Sanjayrao Mahajan	P	P
EE-412	Dhanshri Dhanraj Khadse	P	P
EE-417	Kalyani Shankarrao Gomase	P	
EE-418	Kiran Manohar Gaikwad	P	P
EE-419	Komal Rameshwar Chaudhari	P	P
EE-420	Minali Shantaram Dhurve		P
EE-421	Neha Gunvanta Kumbhare	P	P
EE-423	Prachi Siddharth Patil	P	P
EE-424	Pratiksha Giridhar Gopal	P	P
EE-425	Puja Ankush Meshram	P	P
EE-426	Ravina Vinod Dhoke		P
EE-427	Rutuja Uttam Pikalmunde	P	P
EE-431	Swati Prabhakar Sahare	P	P
EE-432	Sweety Suresh Paunikar	P	
EE-433	Tejaswini Ravindra Bhojar		P
EE-434	Abhishek Suresh Bobade	P	P
EE-438	Ashish Santosh Yanpalliwar	P	P
EE-439	Ayush Moreshwar Chaudhari	P	P
EE-441	Chetan Arvind Getme	P	P
EE-442	Harshad Ramkrushna Shende	P	P
EE-445	Kunal Manohar Gawarle	P	
EE-446	Lavanya Satish Kadam	P	P
EE-450	Mrunal Sharad Shikhare	P	P
EE-452	Pawan Parishlal Rahangdale	P	P
EE-456	Rutvik Rajendraji Ghonge		P
EE-460	Shivraj Kameshwar Singh	P	P



NAGPUR INSTITUTE OF TECHNOLOGY

(Affiliated to RTM Nagpur University & Approved by AICTE New Delhi)

CAMPUS : 13/2, Mahurzari, Near Fetri, Katol Road, Nagpur-441501, India

Email Id : registrar@nit.edu.in Web : www.nit.edu.in Contact No. 09764974144

RTMNU College Code: 315

DTE Code: 4144

AICTE ID : 1-4830701

Department of Electrical Engineering
Session 2023-24

EE-461	Shreejit Rajendra Chandankar		P
--------	------------------------------	--	---

Prof. S. D. Khadse
Coordinator

Dr. J. G. Chaudhari
HoD, Electrical

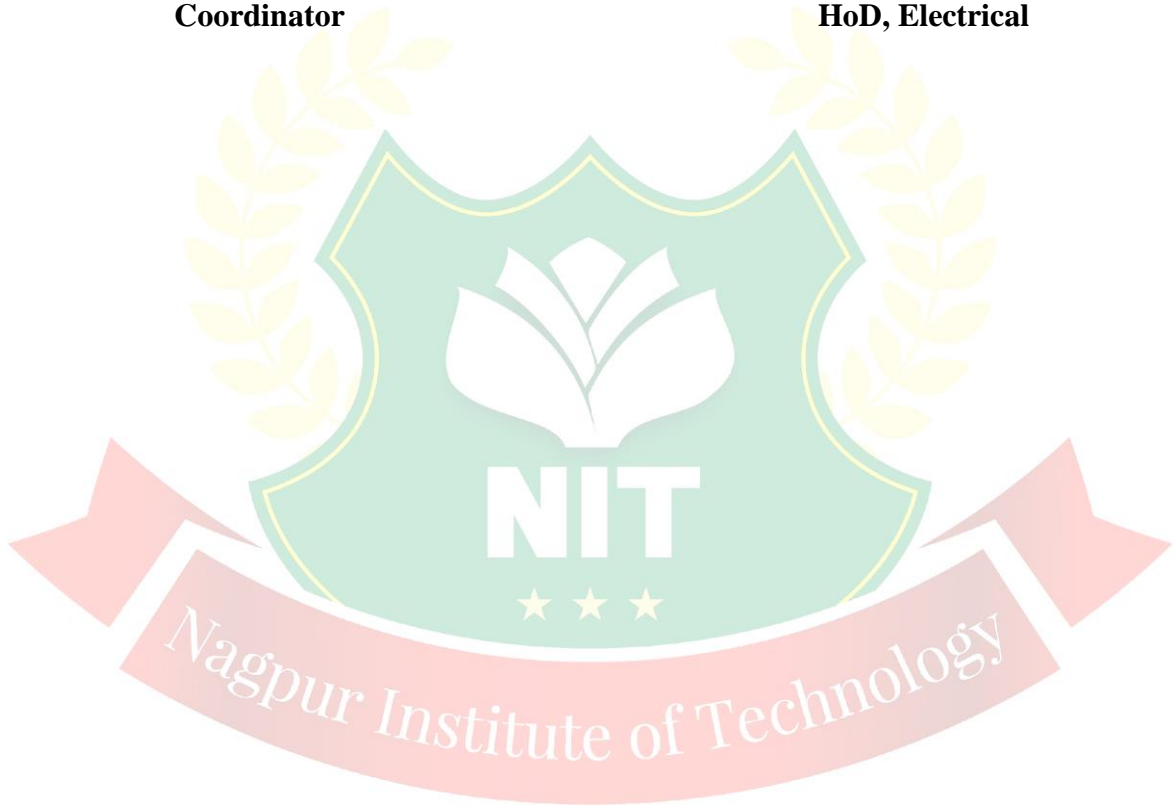



NAGPUR INSTITUTE OF TECHNOLOGY

(Affiliated to RTM Nagpur University & Approved by AICTE New Delhi)

CAMPUS: 13/2, Mahurzari, Near Fetri, Katol Road, Nagpur-441501, India

Email Id: registrar@nit.edu.in Web: www.nit.edu.in Contact No. 09764974144

RTMNU College Code: 315

DTE Code: 4144

AICTE ID : 1-4830701

5.1.2 Following capacity development and skills enhancement activities are organized for improving students' capability in 2022-23

4.Awareness of trends in technology

SN	Name of the capacity development and skills enhancement program	Period (from date - to date)	Number of students enrolled	Name of the agencies/experts involved with contact details
1	2 day Workshop on latest trend in "ASP.NET using c#"	06-04-2023 to 07-04-2023	40	Dr. Rahul Khokle, Thakur COE, Mumbai
2	2 Days workshop on current trends in CNC Part Programming	17-03-2023 to 18-03-2023	37	Prof. Vipin Khangar, Prof. Ghanshyam Dhalwar in association with MSME Technology, Centre-IGTR
3	2 Days Workshop on Solar Based Knowledge Training	20-01-2023 to 21-01-2023	32	Mr. Swapnil Kale & Mr. Akshay Mankar, Trainer & Co founder Green World Energy Nagpur
4	2 days workshop on current trend in Apex Programming for Salesforce Technology	19-10-2022 to 20-10-2022	85	1) Er. Gaurav Dongre, Founder of SketchEdu, Nagpur 2) Er. Gaurishankar Girhe, Salesforce Trainer.
5	2 days Workshop on Autocad Electrical & Revit NEP	27-09-2022 to 28-09-2022	53	Ms Ankita Jogi, Admire Techvision Nagpur
6	2 days workshop on current trends in JAVASCRIPT	25-08-2022 to 26-08-2022	39	Mr. Akshay Moon, Software Developer at Girmiti Software Pvt. Ltd, Bangalore at NIT,Ngp
7	2 days workshop on "NETWORKING AND CLOUD COMPUTING"	14-04-2023 to 15-04-2023	75	Mr. Raj Arora, CEO, Revat Network.



PRINCIPAL
Nagpur Institute of Technology,
Nagpur - 441501.



NAGPUR INSTITUTE OF TECHNOLOGY

(Affiliated to RTM Nagpur University & Approved by AICTE New Delhi)

CAMPUS: 13/2, Mahurzari, Near Fetri, Katol Road, Nagpur-441501, India

Email Id : registrar@nit.edu.in Web : www.nit.edu.in Contact No. 09764974144

RTMNU College Code: 315

DTE Code: 4144

AICTE ID : 1-4830701

Department of Information Technology

Notice/Circular

Date: 03/04/2023

All the students of Information Technology are hereby informed that the Department of Information Technology is organising, the **2 Days Workshop on Latest Trend in “ASP.NET using C#”** on 07th & 8th April 2023 at 12.00 p.m. The students of third year of information technology should attend and actively participate in the event Computer Lab, 3rd Floor A-Wing

Coordinator
Prof. Tushar Shelke

HOD
Dr. M. Makesar
Information Technology Dept
Nagpur Institute of Technology
Nagpur.

Copy To:

- 1) The Principal, NIT, Nagpur
- 2) The Dean(Academics), NIT, Nagpur





NAGPUR INSTITUTE OF TECHNOLOGY

(Affiliated to RTM Nagpur University & Approved by AICTE New Delhi)

CAMPUS: 13/2, Mahurzari, Near Fetri, Katol Road, Nagpur-441501, India

Email Id : registrar@nit.edu.in Web : www.nit.edu.in Contact No. 09764974144

RTMNU College Code: 315

DTE Code: 4144

AICTE ID : 1-4830701

Department of Information Technology

Date: 08th April, 2023

Report:- 2 Days Workshop on Latest Trend in “ASP.NET using C#”

Department	: Department Of Information Technology
Event Title/Activity Name	: 2 days Workshop on Latest Trend in ASP.NET using C#
Date & Time	: 06/04/2023 & 07/04/2023 from 12 O'clock
Venue	: Computer Lab Third Floor A-Wing
Program Co-ordinator	: Prof. Tushar Shelke
Objective Of Program	: To aware the students about the new technology like ASP.NET & C#

Details of Event

The Department Of Information Technology of Nagpur Institute of Technology organized a 2 days Workshop on Latest Trend in ASP.NET using C# for the students of 3rd year was held on 6th of April 2023.

Prof.Tushar Shelke gave the introductory remarks. A total 40 Students participated from 3rd year of Information Technology Dept.

The Expert Speaker Dr.Rahul Khokle from Thakur College of Engineering, Mumbai was the resource person for the session. In his lecture, he discussed the present trends in web technologies and emphasized the importance of ASP & C# . He also explained to the students what are the concepts that the present software companies are looking for and he gave a brief overview of the ASP.NET & C#. He also has given an introduction about the Android applications with live execution. Finally, he discussed the basic concepts that anyone should know to start a research in web technologies.

At the Concluding Dr. M. M.Makesar Appreciated the event that the session was very helpful for the students to help for the future. Prof.Tushar Shelke work hard for the success of the event.

Program Proceeding was handled by Ms.Nidhi Gajimwar, student of 2nd year.

Coordinator
Prof. Tushar Shelke

HOD
Information Technology Dept.
Nagpur Institute of Technology
Nagpur.



NAGPUR INSTITUTE OF TECHNOLOGY

(Affiliated to RTM Nagpur University & Approved by AICTE New Delhi)

CAMPUS: 13/2, Mahurzari, Near Fetri, Katol Road, Nagpur-441501, India

Email Id : registrar@nit.edu.in Web : www.nit.edu.in Contact No. 09764974144

RTMNU College Code: 315

DTE Code: 4144

AICTE ID : 1-4830701

Department of Information Technology

Glimpses Of the Event:



POCO
SHOT ON POCO M2

Coordinator
Prof. Tushar Shelke

H.O.D.
Information Technology Dept.
Nagpur Institute of Technology
Dr. M. Wakesar



NAGPUR INSTITUTE OF TECHNOLOGY

(Affiliated to RTM Nagpur University & Approved by AICTE New Delhi)

CAMPUS: 13/2, Mahurzari, Near Fetri, Katol Road, Nagpur-441501, India

Email Id : registrar@nit.edu.in Web : www.nit.edu.in Contact No. 09764974144

RTMNU College Code: 315

DTE Code: 4144

AICTE ID : 1-4830701

Department of Information Technology

List of present students from 3rd year

Name Of Student	Status	Name Of Student	Status
Aanchal Pramod Vishwakarma	P	Pinal Rajpal Dhanvij	
Achal Krushnrao Badode	P	Piyush Ganesh Selotkar	
Aditya Ratan Moreshiya		Prajwal Rajkumar Kewat	P
Akanksha Masram	P	Prajwal Ramesh Warokar	P
Aniket Arun Janbandhu	P	Pranali Chauke	
Arpan Bisundeo Mandal		Prashik Vinod Dhabarde	P
Ayush Rajendra Bhangre	P	Prathmesh Sanjay Khobragade	
Badal Niranjana Janbandhu	P	Pratiksha Ganesh Selokar	P
Damini Anil Chaube	P	Pravin Bhimrao Pal	P
Dhammshil Jivan Meshram	P	Priyanshu Bagde	
Ekankshi Sanjiv Barekar	P	Ragini Shamrao Motankar	P
Harshal Yadavrao Mirche		Rani Rajendra Dhanjode	
Harshdip Bhagat	P	Ritik Anil Balvir	P
Janhavi Yawale	P	Riya Pijush Dey	P
Janvi Baban Khobragade	P	Rohit Nandu Banot	P
Kajal Babarao Dakhare		Rushali Umesh Parse	P
Karan Madhukar Sahare	P	Rushika Shrikant Ambade	
Khushi Kishor Jain		Rutuparna Nitin Barde	P
Komal Moreshwar Lanjewar	P	Sakshi Krishna Ukey	P
Kuldipak Indalji Meshram	P	Sakshi Ramesh Sahare	
Mayuri Gajanan Hood		Sakshi Sudhakar Bawane	P
Milind Girish Mahajan	P	Samiksha Ravindra Thakre	P
Mitali Sudarshan Sahu	P	Sanjana Banduji Shahare	
Mohammad Ehtesham Abdul Mubin	P	Shafiya Anam Khan	P
Nikhil Mahendra Ramteke		Shreya Ashok Kotangale	P
Nikita Manoj Wankhede	P	Shreya Sanjay Kotamkar	
Nikita Narayan Lolekar	P	Sima Udaram Nikhade	P
Nilesh Sanjayrao Bhise		Sohail Saide	P
Nishikant Shrimohan Chaware	P	Spandan Vandeo Patil	
Oshin Sushil Paul		Tanvi Sushil Nagrare	P

Coordinator
Prof. Tushar Shelke

H.O.D.
Information Technology Dept.
Nagpur Institute of Technology
Dr. M. Makesar



NAGPUR INSTITUTE OF TECHNOLOGY

(Affiliated to RTM Nagpur University & Approved by AICTE New Delhi)

CAMPUS: 13/2, Mahurzari, Near Fetri, Katol Road, Nagpur-441501, India

Email Id : registrar@nit.edu.in Web : www.nit.edu.in Contact No. 09764974144

RTMNU College Code: 315

DTE Code: 4144

AICTE ID : 1-4830701

Department of Mechanical Engineering

Date: 18/03/2023

NOTICE

Mechanical Engineering Department is organizing seminar for Second, Third and final year students on on CNC Milling programming. All are informed to be present on 20/03/2023 at 11.30AM to 01.00PM in CAD Lab.

Prof. Rohan A. Deshmukh
Coordinator

Dr. V N Kalbande
HOD, ME
Mechanical Engineering
Nagpur Institute of Technology, Nagpur

Copy To:

Class Incharge 3rd & 4th Year

HOD, ME



NAGPUR INSTITUTE OF TECHNOLOGY

(Affiliated to RTM Nagpur University & Approved by AICTE New Delhi)

CAMPUS: 13/2, Mahurzari, Near Fetri, Katol Road, Nagpur-441501, India

Email Id : registrar@nit.edu.in Web : www.nit.edu.in Contact No. 09764974144

RTMNU College Code: 315

DTE Code: 4144

AICTE ID : 1-4830701

Department of Mechanical Engineering

Date:21/03/2023

Seminar Report

Session : 2022-2023
Department : Mechanical Engineering
Topic : CNC Milling programming
Date & Time of interaction :20/03/2023 from 11:30AM to 1:00 PM
Name of Expert : Mr. Saikumar
Organization : Indo German Tool Room, Nagpur
No of students participated : 36 students from 3rd& 4th Year

Event Details:

CNC Milling programming in association with MSME Technology Center-IGTR, Nagpur on 20th March 2023. Mr. Saikumar from Indo German Tool Room, Nagpur.

Glimpses of Workshop :



Prof. Rohan A. Deshmukh
Coordinator

Dr. V N Kalbande
HOD, ME
Mechanical Engineering
Nagpur Institute of Technology, Nagpur



NAGPUR INSTITUTE OF TECHNOLOGY

(Affiliated to RTM Nagpur University & Approved by AICTE New Delhi)

CAMPUS: 13/2, Mahurzari, Near Fetri, Katol Road, Nagpur-441501, India

Email Id : registrar@nit.edu.in Web : www.nit.edu.in Contact No. 09764974144

RTMNU College Code: 315

DTE Code: 4144

AICTE ID : 1-4830701

Department of Mechanical Engineering

VI SEM LIST

Roll No.	Students Name	ATTENDANCE
301	Payal Krushnaji Lokhande	P
302	Pranali Ravindra Meshram	P
303	Pratiksha Dinesh Manwatkar	P
304	Priyanka Vinayak Tumlam	P
305	Rajshi Anklesh Indurkar	
306	Sagar Nepal Chamlate	
307	Sanskruti S.Chokhandre	P
308	Shravani Dinesh Kadu	P
309	Tusharika Manohar Mahalle	P
310	Abhilash Bharat Murar	P
311	Abhishek Manojkumar Solanki	P
312	Abhishek Narayan Sakharkar	
313	Adarsh Natthuji Dhunde	
314	Aditya Jagannath Kelwade	
315	Aditya Vijayrao Boratkar	
316	Akash Kundlik Mene	P
317	Akash Maroti Shendre	P
318	Aman Ansari	
319	Amar Adnyan Pendram	
320	Amin Mammusabu Pathan	
321	Aniruddh Laxman Sonkamble	P
322	Aniruddha Sonekar	P
323	Ankush Ganesh Chaudhary	P

Prof. Rohan A. Deshmukh
Coordinator

Dr. V N Kalbande
HOD, ME
Mechanical Engineering
Nagpur Institute of Technology, Nagpur



NAGPUR INSTITUTE OF TECHNOLOGY

(Affiliated to RTM Nagpur University & Approved by AICTE New Delhi)

CAMPUS: 13/2, Mahurzari, Near Fetri, Katol Road, Nagpur-441501, India

Email Id : registrar@nit.edu.in Web : www.nit.edu.in Contact No. 09764974144

RTMNU College Code: 315

DTE Code: 4144

AICTE ID : 1-4830701

Department of Mechanical Engineering

VIII SEM LIST

Roll No.	Students Name	ATTENDANCE
401	Akanksha Dhadel	P
402	Anjali Khobragade	P
403	Bhavana Sunderlal Nandanwar	P
404	Bhawana Taywade	
405	Damini Prachi	P
406	Himanshi Barsagade	P
407	Ishika Rathod	P
408	Kanchan Balkrishna Tembhurne	
409	Koyal Hingwe	P
410	Neha Bodhe	P
411	Nutan Babarao Mandale	P
412	Priyanka Sudam Sahu	P
413	Shital Prabhakar Nikose	
414	Swati Suresh Khorgade	P
415	Utkarsha Pathade	
416	Vaishnavi Bitne	P
417	Abdul Talib Abdul Waris	P
418	Abhijit Ramesh Wahane	P
419	Abhishek Meshram	
420	Abhishek Pramodraoji Kakde	P
421	Abhishek Sanjayraoji Umale	P
422	Adarsh Raut	P
423	Ajinkya Pramod Labhshetwar	P

Prof. Rohan A. Deshmukh
Coordinator

Dr. V N Kalbande
HOD, ME
Mechanical Engineering
Nagpur Institute of Technology, Nagpur



NAGPUR INSTITUTE OF TECHNOLOGY

(Affiliated to RTM Nagpur University & Approved by AICTE New Delhi)

CAMPUS : 13/2, Mahurzari, Near Fetri, Katol Road, Nagpur-441501, India

Email Id : registrar@nit.edu.in Web : www.nit.edu.in Contact No. 09764974144

RTMNU College Code: 315

DTE Code: 4144

AICTE ID : 1-4830701

Department of Electrical Engineering
Session 2022-23

Notice

Date: 18/01/2023

All the Students Electrical Engineering Department is hereby informed of a Two Days workshop on : “Solar based knowledge training” Jointly Organized by IE (I) Student Chapter of Department of Electrical Engineering & Green World Energy , Nagpur. As an Internal Quality Assurance cell (IQAC) Initiative under the banner of Feeder Forum on Date 20/01/2023 - 21/01/2023. All students should come in the college uniform.

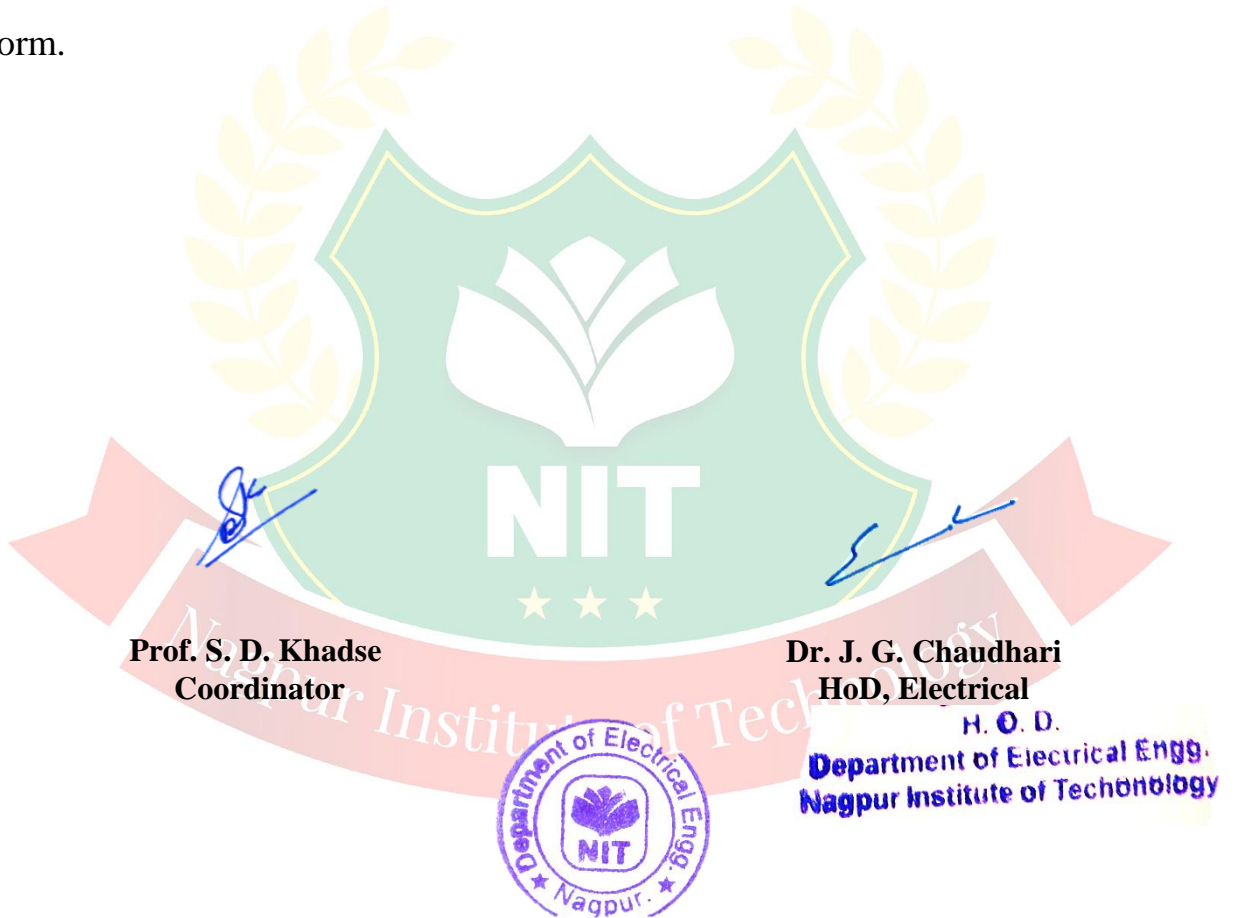



NAGPUR INSTITUTE OF TECHNOLOGY

(Affiliated to RTM Nagpur University & Approved by AICTE New Delhi)

CAMPUS : 13/2, Mahurzari, Near Fetri, Katol Road, Nagpur-441501, India

Email Id : registrar@nit.edu.in Web : www.nit.edu.in Contact No. 09764974144

RTMNU College Code: 315

DTE Code: 4144

AICTE ID : 1-4830701

Department of Electrical Engineering Session 2022-23

Activity Report

Date: 22/01/ 2023

Session	:	2022-2023
In association with	:	Feeder Forum/ IE(I) Student Chapter / Internal Quality Assurance cell (IQAC)
Program Type	:	Workshop
Date & duration	:	20/01/2023 - 21/01/2023
Mode of delivery	:	Online
Title	:	Solar based knowledge training
Name of Expert with Designation	:	Mr. Swapnil Kale and Mr. Akshay mankar Trainer (Co-Founder) Mankar from Green World Energy, Nagpur
Participants	:	Student: 32 Faculty: 04 External:01
Objective of program	:	To Enhance a skill among students along with the theoretical part to fill the gap between academic and industry.

Introduction:

Department of Electrical Engineering, Nagpur Institute of Technology, Nagpur organized a Two Days workshop on : "Solar based knowledge training" Jointly Organized by IE (I) Student Chapter of Department of Electrical Engineering & Green World Energy , Nagpur. As an Internal Quality Assurance cell (IQAC) Initiative under the banner of Feeder Forum on Date 20/01/2023 - 21/01/2023. The Trainer (Co-Founder) Mr. Swapnil Kale and Mr. Akshay Mankar from Green World Energy, Nagpur had delivered the Session considering future aspects to Research in Solar and its design with applications as in today's era.



NAGPUR INSTITUTE OF TECHNOLOGY

(Affiliated to RTM Nagpur University & Approved by AICTE New Delhi)

CAMPUS : 13/2, Mahurzari, Near Fetri, Katol Road, Nagpur-441501, India

Email Id : registrar@nit.edu.in Web : www.nit.edu.in Contact No. 09764974144

RTMNU College Code: 315

DTE Code: 4144

AICTE ID : 1-4830701

Department of Electrical Engineering Session 2022-23



Inaugural function of workshop with the Hands of Respected HoD Dr. J. G. Chaudhari.

Day-I: All 32 participants gathered at Class Room B204, Expert (Co-founder) Mr. Swapnil Kale & Mr. Akshay Mankar guided participants on specification of all components related to solar panel also showed demonstration of different activities about solar panel. The day ends with a homework task.



Day- I Session Conducted by Mr. Shrikant Ganjare, Co-founder, Think Solar Nagpur,

Day-II : Visit to Site

Participants visited the site of installation of a Panel at Solar Rooftop owned by Anand Bahar Sweet & Namkeen, Godhani, Nagpur. Mr. Swapnil Kale and his team narrated the students at the beginning and discussed the whole day plan.



NAGPUR INSTITUTE OF TECHNOLOGY

(Affiliated to RTM Nagpur University & Approved by AICTE New Delhi)

CAMPUS : 13/2, Mahurzari, Near Fetri, Katol Road, Nagpur-441501, India

Email Id : registrar@nit.edu.in Web : www.nit.edu.in Contact No. 09764974144

RTMNU College Code: 315

DTE Code: 4144

AICTE ID : 1-4830701

Department of Electrical Engineering Session 2022-23



Day- II Students Visited Anand Bahar Sweet & Namkeen, Godhani, Nagpur and installation work done by students.

Outcome of Lecture:

Students get to know theoretical and Practical part of Solar to fill the gap between academic and industry

Conclusion:

Students get knowledge about Solar PV Installation Theoretically and Practically.

Acknowledgment:

- 1) On behalf of the Electrical Engineering Department we sincerely thank The Trainer (Co-Founder) Mr. Swapnil Kale and Mr. Akshay Mankar from Green World Energy, Nagpur for delivering the Session considering future aspects to Research in Solar and its design with applications as today's era.
- 2) Our deep sense of gratitude to Dr. Amol Deshmukh, Principal, NIT, Nagpur for providing support in organizing the Seminar

Prof. S. D. Khadse
Coordinator

Dr. J. G. Chaudhari
HoD, Electrical

H. O. D.

Department of Electrical Engg.
Nagpur Institute of Technology

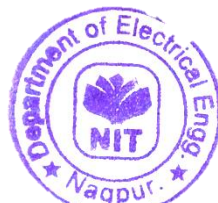



NAGPUR INSTITUTE OF TECHNOLOGY

(Affiliated to RTM Nagpur University & Approved by AICTE New Delhi)

CAMPUS : 13/2, Mahurzari, Near Fetri, Katol Road, Nagpur-441501, India

Email Id : registrar@nit.edu.in Web : www.nit.edu.in Contact No. 09764974144

RTMNU College Code: 315

DTE Code: 4144

AICTE ID : 1-4830701

Department of Electrical Engineering Session 2022-23

Date:-21/10/2022.

Activity Attendance Sheet

Topic : - Solar Based Knowledge Training

Expert Name & Designation: Mr. Swapnil Kale & Mr. Akshay Mankar, Trainer & Co founder

Organization: - Green World Energy Nagpur

Year: - Second Year

Roll. No.	Name of Student	DAY 1	DAY 2
EE201	Ankita Manohar Bhubade	P	P
EE202	Arpita Mahesh Kumre	P	P
EE205	Dipika Batulal Nagpure	P	P
EE208	Esha Surendra Bhondekar	P	P
EE209	Greny Pravin Choudhari	P	P
EE211	Jayshila Baliram Salame	P	P
EE214	Kishori Anil Wasade	P	P
EE215	Krutika Ratnakar Gadge	P	P
EE216	Lalita Manoj Narnaware	P	P
EE220	Pallavi Rajkumar Gajbhiye	P	P
EE223	Pratima Babulal Kumbhare	P	P
EE224	Pritee Manoj Tilgame	P	P
EE227	Punam Madhav Dhengare	P	P
EE228	Punam Rajkumar Kosme	P	P
EE229	Ragini Ranjit Bawane	P	P
EE231	Sandhya Sanjay Meshram	P	P
EE232	Sapna Natthu Gondule	P	P
EE237	Yeshmita Gajanan Bawane	P	P
EE242	Aryan Nitesh Meshram	P	P
EE243	Ayush Sanjayrao Dahiwade	P	P



NAGPUR INSTITUTE OF TECHNOLOGY

(Affiliated to RTM Nagpur University & Approved by AICTE New Delhi)

CAMPUS : 13/2, Mahurzari, Near Fetri, Katol Road, Nagpur-441501, India

Email Id : registrar@nit.edu.in Web : www.nit.edu.in Contact No. 09764974144

RTMNU College Code: 315

DTE Code: 4144

AICTE ID : 1-4830701

Department of Electrical Engineering Session 2022-23

EE247	Harshal Babanrao Sarode	P	P
EE251	Mithilesh Sanjay Tagde	P	P
EE254	Prajwal Bhagwatrao Dhopre	P	P
EE256	Prajwal Sukhadevrao Kadu	P	P
EE260	Pravin Manojkumarr Rahangdale	P	P
EE262	Sanchit Dilip Pantawane	P	P
EE265	Shahanawaz Shafique Sheikh	P	P
EE268	Tanmay Dhiraj Lanjewar	P	P
EE210	Hina Wasnik	P	P
EE267	Sushant Pradip Gawai	P	P
EE245	Chinmay Manoharrao Rewaskar	P	P
EE253	Prajwal Anil Mandape	P	P

Prof. S. D. Khadse
Coordinator

Dr. J. G. Chaudhari
HoD, Electrical



NAGPUR INSTITUTE OF TECHNOLOGY

(Affiliated to RTM Nagpur University & Approved by AICTE New Delhi)

CAMPUS: 13/2, Mahurzari, Near Fetri, Katol Road, Nagpur-441501, India

Email Id : registrar@nit.edu.in Web : www.nit.edu.in Contact No. 09764974144

RTMNU College Code: 315

DTE Code: 4144

AICTE ID : 1-4830701

Department of Information Technology

Notice/Circular

Date: 14/10/2022

All the students of Information Technology are hereby informed that the Department of Information Technology is organising, the **2 days Workshop on Current Trend in “Apex Programming for Salesforce”** on 19th & 20th Oct 2022 at 11.00 a.m. The students of second year, third year and final year of information technology should attend and actively participate in the event Computer Lab, 3rd Floor A-Wing

Coordinator

H.O.D.
Information Technology Dept.
Nagpur Institute of Technology
Nagpur.

Copy To:

- 1) The Principal, NIT, Nagpur
- 2) The Dean(Academics), NIT, Nagpur





NAGPUR INSTITUTE OF TECHNOLOGY

(Affiliated to RTM Nagpur University & Approved by AICTE New Delhi)

CAMPUS: 13/2, Mahurzari, Near Fetri, Katol Road, Nagpur-441501, India

Email Id : registrar@nit.edu.in Web : www.nit.edu.in Contact No. 09764974144

RTMNU College Code: 315

DTE Code: 4144

AICTE ID : 1-4830701

Department of Information Technology

Date: 21/10/2022

Report of- 2 days Workshop on Current Trend in “Apex Programming for Salesforce”

Department	: Department of Information Technology
Event Title/Activity Name	: 2 days Workshop on Current Trend in “Apex Programming for Salesforce”
Date & Time	: 19/10/2022 & 20/10/2022 from 11 am
Venue	: Computer Lab Third Floor A-Wing
No of Present Students	: 85
Guest	: 1. Er. Gaurav Dongre, Founder of SketchEdu Technologies, Nagpur 2. Er. Gaurishankar Girhe, Salesforce Trainer.
Program coordinator	: Prof. Samir P. Mendhe
Objective of program	: To aware the students about salesforce technology.

Details of Event:

The Department of Information Technology of Nagpur Institute of Technology organized “Salesforce” for the student of 2nd, 3rd and 4th year.

Prof. Samir Mendhe gave the introductory remarks. Total 85 students participated from Fourth year VII-Sem, Third Year V-Sem and Second Year III-Sem of Information Technology Dept. During the session the expert speaker, started his session with the introduction of salesforce technology and further he explored to the development of the application on salesforce.

At the concluding Prof. Samir Mendhe Appreciated the event that the session was very helpful for the students to help businesses find more prospects, close more deals, and wow customers with amazing service. Prof. Samir Mendhe work hard for the success of the event. Program proceedings was handled by Ms. Khushi Gupta student of 2nd year.

Coordinator

M.O.D.
Information Technology Dept.
Nagpur Institute of Technology
Nagpur.



NAGPUR INSTITUTE OF TECHNOLOGY

(Affiliated to RTM Nagpur University & Approved by AICTE New Delhi)

CAMPUS: 13/2, Mahurzari, Near Fetri, Katol Road, Nagpur-441501, India

Email Id : registrar@nit.edu.in Web : www.nit.edu.in Contact No. 09764974144

RTMNU College Code: 315

DTE Code: 4144

AICTE ID : 1-4830701

Department of Information Technology

Glimpses of The Event :



Nagpur Institute of Technology

Registrar
Coordinator

Simple
M.O.D
Information Technology Dept.
Nagpur Institute of Technology
Nagpur.



NAGPUR INSTITUTE OF TECHNOLOGY

(Affiliated to RTM Nagpur University & Approved by AICTE New Delhi)

CAMPUS: 13/2, Mahurzari, Near Fetri, Katol Road, Nagpur-441501, India

Email Id : registrar@nit.edu.in Web : www.nit.edu.in Contact No. 09764974144

RTMNU College Code: 315

DTE Code: 4144

AICTE ID : 1-4830701

Department of Information Technology

List of present students from 3rd year

Name Of Student	Status	Name Of Student	Status
Aanchal Pramod Vishwakarma	P	Pinal Rajpal Dhanvij	
Achal Krushnrao Badode	P	Piyush Ganesh Selotkar	
Aditya Ratan Moreshiya		Prajwal Rajkumar Kewat	P
Akanksha Masram	P	Prajwal Ramesh Warokar	P
Aniket Arun Janbandhu	P	Pranali Chauke	
Arpan Bisundeo Mandal		Prashik Vinod Dhabarde	P
Ayush Rajendra Bhangre	P	Prathmesh Sanjay Khobragade	
Badal Niranjana Janbandhu	P	Pratiksha Ganesh Selokar	P
Damini Anil Chaube		Pravin Bhimrao Pal	
Dhammshil Jivan Meshram		Priyanshu Bagde	
Ekankshi Sanjiv Barekar	P	Ragini Shamrao Motankar	P
Harshal Yadavrao Mirche		Rani Rajendra Dhanjode	
Harshdip Bhagat	P	Ritik Anil Balvir	P
Janhavi Yawale	P	Riya Pijush Dey	P
Janvi Baban Khobragade	P	Rohit Nandu Banot	P
Kajal Babarao Dakhare		Rushali Umesh Parse	P
Karan Madhukar Sahare	P	Rushika Shrikant Ambade	
Khushi Kishor Jain		Rutuparna Nitin Barde	P
Komal Moreshwar Lanjewar	P	Sakshi Krishna Ukey	P
Kuldipak Indalji Meshram	P	Sakshi Ramesh Sahare	
Mayuri Gajanan Hood		Sakshi Sudhakar Bawane	P
Milind Girish Mahajan	P	Samiksha Ravindra Thakre	P
Mitali Sudarshan Sahu		Sanjana Banduji Shahare	
Mohammad Ehtesham Abdul Mubin	P	Shafiya Anam Khan	P
Nikhil Mahendra Ramteke		Shreya Ashok Kotangale	P
Nikita Manoj Wankhede	P	Shreya Sanjay Kotamkar	P
Nikita Narayan Lolekar	P	Sima Udaram Nikhade	P
Nilesh Sanjayrao Bhise		Sohail Saide	P
Nishikant Shrimohan Chaware	P	Spandan Vandeo Patil	
Oshin Sushil Paul	P	Tanvi Sushil Nagrare	P
Pallavi Chandramani Wasnik	P	Vaishnavi Rajesh Balne	P
Pallavi Mahadev Karemore	P	Vaishnavi Sachin Gandhewar	
Pavan Ravindra Mahalle	P	Vina Dilip Pande	P
Payal Ashok Nikose	P	Vishakha Ganesh Dhawad	P
Payal Suresh Turkar	P		



NAGPUR INSTITUTE OF TECHNOLOGY

(Affiliated to RTM Nagpur University & Approved by AICTE New Delhi)

CAMPUS: 13/2, Mahurzari, Near Fetri, Katol Road, Nagpur-441501, India

Email Id : registrar@nit.edu.in Web : www.nit.edu.in Contact No. 09764974144

RTMNU College Code: 315

DTE Code: 4144

AICTE ID : 1-4830701

Department of Information Technology

List of present students from 4th year

Name Of Student	Status	Name Of Student	Status
Abhijit Dindayal Kharपुरiya	P	Prajakta Yashwant Thakre	
Achal Roshan Gaurkhede	P	Pranjal Abhimanyu Kuhikar	P
Akanksha Ramchandra Nasre		Pranjali Ravindra Kanhekar	
Akash Bhagwan Meshram	P	Pratik Sudhakar Deshmukh	P
Akash Haresh Bodle	P	Prince Kumar Chandrashekhar Singh	
Aniket Yashwant Potbhare		Prince Mahesh Wasnik	P
Anisha Rajkumar Ganvir	P	Pritika Kailas Kolte	P
Anjali Ambadas Dongre		Priya Prabhu Patil	P
Anjali Omprakash Patankar	P	Priyanka Arun Jumle	
Anjali Sukhram Matre	P	Priyanka Bholaram Puriya	P
Anshul Rajesh Thakre		Rinku Natthuji Sonkusale	
Apurva Suryakant Chokhandre	P	Ritik Dilip Dhabale	P
Ashwini Bhagwanji Dhok		Ritik Ravindra Doijod	
Ashwini Omkar Choure		Ruchika Diwakarji Parate	P
Chaitali Chandrashekhar Kathwate	P	Rushali Marotrao Sawai	P
Chaitali Sunil Akhand	P	Sakshi Ashok Kamone	P
Chaitanya Harish Deotale	P	Sakshi Pradeep Chimote	P
Chetna Surendra Katre		Samyak Nandu Somkuwar	
Himanshu A K Pandey	P	Santoshi Suresh Mahato	P
Hitesh Gyanchand Bhagat		Sanyukta Shivshankar Gajbhiye	P
Jay Omeshwar Pardhi	P	Saurabh Moreshwar Sakharkar	
Kaushik Sunil Hiranwar		Saurabh Rajendra Surjuse	P
Kirti Kamleshwar Banewar	P	Shanu Gulab Rahule	P
Komal Vasudev Tibole	P	Sharda Samarlal Barmaiya	
Krunal Dnyaneshwar Khapekar		Shivani Narendra Mishra	P
Kunda Subhash Pandhare	P	Shreyash Bharat Gajbhiye	P
Maheshwari Virendra Gotmare		Shrutika Prashant Shelke	
Mansi Shekhar Sheware	P	Sumit Murlidhar Wakode	P
Namita Ramesh Bawane		Tanuja Rajendra Nehare	P
Nikita Ambadas Patil	P	Tejas Pradeep Kamble	
Nitika Ganesh Sonwane	P	Tejasvi Patil	P
Pallavi Kishor Bhasme		Vishal Chandrashekhar Ikhe	P
Pooja Sanjay Gajbhiye	P	Vivek Uttam Chaple	P
Poonam Rambhau Bramhane		Yukta Panjabrao Pagare	

Coordinator

M.O.D.
Information Technology Dept.
Nagpur Institute of Technology
Nagpur.

NAGPUR INSTITUTE OF TECHNOLOGY



(Affiliated to RTM Nagpur University & Approved by AICTE New Delhi)

CAMPUS : 13/2, Mahurzari, Near Fetri, Katol Road, Nagpur-441501, India

Email Id : registrar@nit.edu.in Web : www.nit.edu.in Contact No. 09764974144

RTMNU College Code: 315

DTE Code: 4144

AICTE ID : 1-4830701

Department of Electrical Engineering
Session 2022-23

Notice

Date: 24/09/2022

All the Students of Electrical Engineering department is hereby informed that workshop by, **Ms Ankita Jogi, Admire Techvision Nagpur** on the topic “**2 days Workshop on Autocad Electrical & Revit NEP**” is arranged on date 27/09/2022 to 28/09/2022. All students should come in the college uniform.





Prof. S. D. Khadse
Coordinator

Dr. J. G. Chaudhari
HoD, Electrical

H. O. D.

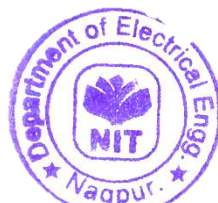
Department of Electrical Engg.
Nagpur Institute of Technology





NAGPUR INSTITUTE OF TECHNOLOGY

(Affiliated to RTM Nagpur University & Approved by AICTE New Delhi)

CAMPUS : 13/2, Mahurzari, Near Fetri, Katol Road, Nagpur-441501, India

Email Id : registrar@nit.edu.in Web : www.nit.edu.in Contact No. 09764974144

RTMNU College Code: 315

DTE Code: 4144

AICTE ID : 1-4830701

Department of Electrical Engineering Session 2022-23

Activity Report

Date: 28//09/2022

Session	:	2022-2023
In association with	:	Feeder Forum/ IE(I) Student Chapter / Internal Quality Assurance cell (IQAC)
Program Type	:	Workshop
Date & duration	:	27/09/2022 - 28/09/2022
Mode of delivery	:	Offline
Title	:	Workshop on Autocad Electrical & Revit NEP
Name of Expert with Designation	:	Ms Ankita Jogi, Admire Techvision Nagpur
Participants	:	Student: 53 Faculty: 02 External:00
Objective of program	:	To Bestow the students with knowledge and latest technical updates about AutoCAD Electrical and Revit MEP.

Introduction:

Department of Electrical Engineering, Nagpur Institute of Technology, Nagpur organized a Two Days workshop on : "Workshop on Autocad Electrical & Revit NEP" Jointly Organized by IE (I) Student Chapter of Department of Electrical Engineering. As an Internal Quality Assurance cell (IQAC) Initiative under the banner of Feeder Forum on Date 27/09/2022 - 28/09/2022. The Expert Ms Ankita Jogi, Admire Techvision Nagpur had delivered the Session considering future aspects of Autocad Electrical & Revit NEP.

Inaugural function of workshop with the Hands of Respected HoD Dr. J. G. Chaudhari.

Day-I: All 55 participants gathered at Room no 205, Expert Ms Ankita Jogi, and assistant Admire Techvision Nagpur guided participants on latest technical updates about AutoCAD Electrical and Revit MEP..

Day-II: Experts show demo videos of new tools of AutoCAD Electrical and Revit MEP.



NAGPUR INSTITUTE OF TECHNOLOGY

(Affiliated to RTM Nagpur University & Approved by AICTE New Delhi)

CAMPUS : 13/2, Mahurzari, Near Fetri, Katol Road, Nagpur-441501, India

Email Id : registrar@nit.edu.in Web : www.nit.edu.in Contact No. 09764974144

RTMNU College Code: 315

DTE Code: 4144

AICTE ID : 1-4830701

Department of Electrical Engineering Session 2022-23



Outcome of Seminar :

Students get to know theoretical and Practical part of AutoCAD Electrical and Revit MEP to fill the gap between academic and industry

Conclusion:

Students get knowledge about different tools of AutoCAD Electrical and Revit MEP Theoretically and Practically.

Acknowledgment:

- 1) On behalf of the Electrical Engineering Department we sincerely thank Ms Ankita Jogi, and assistant Admire Techvision Nagpur for accepting our invitation and delivering a Workshop on “AutoCAD Electrical and Revit MEP to fill the gap between academic and industry” to our students.
- 2) Our deep sense of gratitude to Dr. Amol Deshmukh, Principal, N.I.T. for providing support in organizing the Seminar.

Prof. S. D. Khadse
Coordinator

Dr. J. G. Chaudhari
HoD, Electrical

H. O. D.

Department of Electrical Engg.
Nagpur Institute of Technology

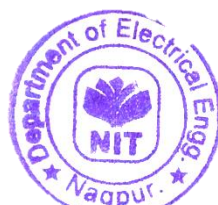



NAGPUR INSTITUTE OF TECHNOLOGY

(Affiliated to RTM Nagpur University & Approved by AICTE New Delhi)

CAMPUS : 13/2, Mahurzari, Near Fetri, Katol Road, Nagpur-441501, India

Email Id : registrar@nit.edu.in Web : www.nit.edu.in Contact No. 09764974144

RTMNU College Code: 315

DTE Code: 4144

AICTE ID : 1-4830701

Department of Electrical Engineering Session 2022-23

Date:-28//09/2022

Activity Attendance Sheet

Topic: - 2 Days Workshop on Autocad Electrical & Revit NEP

Expert Name & Designation: Ms Ankita Jogi, Admire Techvision Nagpur

Organization: - Admire Techvision Nagpur

Year: - Final Year

Roll. No.	Name of Student	DAY 1	DAY 2
EE-402	Aishwarya Ghanshyam Alone	P	P
EE-403	Aishwarya Jivansingh Gour	P	P
EE-404	Aishwarya Sanjay Yesankar	P	P
EE-405	Anuradha Subhashn Mahalvanshi	P	P
EE-406	Arti Ashok Karnake	P	P
EE-408	Asmita Vijaykumar Narnawre	P	P
EE-409	Dhanashree Purushottam Judpe	P	P
EE-410	Dhanashri Suresh Shembekar	P	P
EE-411	Dhanshree Sanjayrao Mahajan	P	P
EE-412	Dhanshri Dhanraj Khadse	P	P
EE-413	Diksha Gautre	P	P
EE-414	Harsha Yograj Mendhe	P	P
EE-415	Harshada Ramkrishna Waghmare	P	P
EE-416	Jayashree Sanjay Pacharne	P	P
EE-417	Kalyani Shankarrao Gomase	P	P
EE-419	Komal Rameshwar Chaudhari	P	P
EE-421	Neha Gunvanta Kumbhare	P	P
EE-422	Nikita Umesh Sukhadeve	P	P
EE-423	Prachi Siddharth Patil	P	P

NAGPUR INSTITUTE OF TECHNOLOGY



(Affiliated to RTM Nagpur University & Approved by AICTE New Delhi)

CAMPUS : 13/2, Mahurzari, Near Fetri, Katol Road, Nagpur-441501, India

Email Id : registrar@nit.edu.in Web : www.nit.edu.in Contact No. 09764974144

RTMNU College Code: 315

DTE Code: 4144

AICTE ID : 1-4830701

Department of Electrical Engineering Session 2022-23

EE-424	Pratiksha Giridhar Gopal	P	P
EE-425	Puja Ankush Meshram	P	P
EE-427	Rutuja Uttam Pikalmunde	P	P
EE-428	Shefali Maroti Sahare	P	P
EE-429	Shivani Ganeshrao Hadke	P	P
EE-431	Swati Prabhakar Sahare	P	P
EE-432	Sweety Suresh Paunekar	P	P
EE-433	Tejaswini Ravindra Bhoyar	P	P
EE-434	Abhishek Suresh Bobade	P	P
EE-438	Ashish Santosh Yanpalliwar	P	P
EE-439	Ayush Moreshwar Chaudhari	P	P
EE-440	Bharat Anandrao Tirode	P	P
EE-441	Chetan Arvind Getme	P	P
EE-443	Harshal Wasudeorao Patil	P	P
EE-445	Kunal Manohar Gawarle	P	P
EE-446	Lavanya Satish Kadam	P	P
EE-447	Madhur Sukhadeo Bawankule	P	P
EE-448	Mayur Kundan Meshram	P	P
EE-449	Mohit Babarao Raut	P	P
EE-450	Mrunal Sharad Shikhare	P	P
EE-451	Nitesh Tarachand Sherkhure	P	P
EE-452	Pawan Parishlal Rahangdale	P	P
EE-453	Rajendra Chaitram Dongre	P	P
EE-454	Rakesh Janardan Chipde	P	P

NAGPUR INSTITUTE OF TECHNOLOGY



(Affiliated to RTM Nagpur University & Approved by AICTE New Delhi)

CAMPUS : 13/2, Mahurzari, Near Fetri, Katol Road, Nagpur-441501, India

Email Id : registrar@nit.edu.in **Web** : www.nit.edu.in **Contact No.** 09764974144

RTMNU College Code: 315

DTE Code: 4144

AICTE ID : 1-4830701

Department of Electrical Engineering Session 2022-23

EE-455	Rushikesh Manoj Sakhare	P	P
EE-456	Rutvik Rajendraji Ghonge	P	P
EE-457	Sameer Nanduji Ganorkar	P	P
EE-458	Sanmay Banduji Ghangale	P	P
EE-459	Saurabh Pramodrao Tayde	P	P
EE-460	Shivraj Kameshwar Singh	P	P
EE-463	Sumedh Sahebrao Khillare	P	P
EE-464	Tanil Ashok Kadam	P	P
EE-465	Tejas Gajanan Raut	P	P
EE-466	Uday Sadashivrao Kuthe	P	P

Prof. S. D. Khadse
Coordinator

Dr. J. G. Chaudhari
HoD, Electrical

Nagpur Institute of Technology



NAGPUR INSTITUTE OF TECHNOLOGY

(Affiliated to RTM Nagpur University & Approved by AICTE New Delhi)

CAMPUS: 13/2, Mahurzari, Near Fetri, Katol Road, Nagpur-441501, India

Email Id :registrar@nit.edu.in Web : www.nit.edu.in Contact No. 09764974144

RTMNUCollege Code: 315

DTE Code: 4144

AICTE ID :1-4830701

Department of Computer Science and Engineering

Session: 2022-23

Date: 22-08-2022

Notice

All the students of B.Tech-Third & Fifth Sem are hereby informed that the, CSE Department is organizing 2 daysWorkshop on“**Java Script**” is schedule on dated 25-08-2022 to 26-08-2022. All the students must be present at the mentioned venue & time below.

Venue: Online

Prof. Mohammad Sajid
Event Coordinator

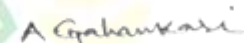
Prof. A. Gahankari
Head, CSE Deptt.
H.O.D.
Computer Science & Engineering Dept.
Nagpur Institute of Technology
Nagpur.

Copy To:

1. Circulation in Class of VI, VIII Semester
2. Notice Board
3. Office File

Nagpur Institute of Technology



NAGPUR INSTITUTE OF TECHNOLOGY

(Affiliated to RTM Nagpur University & Approved by AICTE New Delhi)

CAMPUS: 13/2, Mahurzari, Near Fetri, Katol Road, Nagpur-441501, India

Email Id :registrar@nit.edu.in Web : www.nit.edu.in Contact No. 09764974144

RTMNUCollege Code: 315

DTE Code: 4144

AICTE ID :1-4830701

Department of Computer Science and Engineering

Session: 2022-23

Date: 26/8/2022

Activity Report

Activity Title	: Java Script
Expert Detail	: Mr. Akshay Moon, Software Developer at Girmiti Software Pvt. Ltd, Bangalore at NIT,Ngp
Date & Time	: 25 /08 /2022 To 26/8/2022, 12:00pm
Mode of Conduction	: ONLINE
Participants	: Student: 88 Faculty:02
Objective of program	: To help Students to elaborated the careerprospects knowledge about Scripting languages give live demo for how to use java script in web browser.
Program coordinator	: Prof. Mohammad Sajid

The Department of Computer Science and Engineering of NIT, Nagpur has successfully organized a **Workshop on “Java Scriptfor B.Tech-Third & Fifth Sem”** by **Mr. Akshay Moon, Software Developer at Girmiti Software Pvt. Ltd, Bangalore** at NIT, Nagpur on 25/08/2022. Total 88 Students from CSE Departments were present for the workshop online in CSE Lab. They guided students regarding Scripting and gives live demo showing simple tricks in web browser using java script.. Prof. Shraddha Raut proposed vote of thanks.

Nagpur Institute of Technology



NAGPUR INSTITUTE OF TECHNOLOGY

(Affiliated to RTM Nagpur University & Approved by AICTE New Delhi)

CAMPUS: 13/2, Mahurzari, Near Fetri, Katol Road, Nagpur-441501, India

Email Id :registrar@nit.edu.in Web : www.nit.edu.in Contact No. 09764974144

RTMNUCollege Code: 315

DTE Code: 4144

AICTE ID :1-4830701

Department of Computer Science and Engineering Session: 2022-23

Glimpses of the Event:

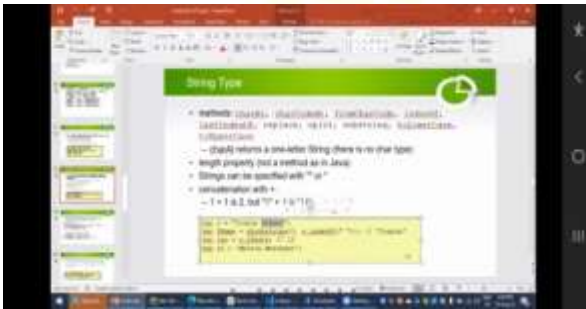

Prof. Mohammad Sajid
Event Coordinator

A. Gahankari
Prof. A. Gahankari
Head, CSE Deptt.
H.O.D.
Computer Science & Engineering Dept.
Nagpur Institute of Technology
Nagpur.



NAGPUR INSTITUTE OF TECHNOLOGY

(Affiliated to RTM Nagpur University & Approved by AICTE New Delhi)

CAMPUS: 13/2, Mahurzari, Near Fetri, Katol Road, Nagpur-441501, India

Email Id : registrar@nit.edu.in Web : www.nit.edu.in Contact No. 09764974144

RTMNUCollege Code: 315

DTE Code: 4144

AICTE ID :1-4830701

Department of Computer Science and Engineering

Session: 2022-23

List Of Present Students from 3rd year

List Of Present Students from 3 rd year			
NAME OF STUDENTS		NAME OF STUDENTS	
Achal Sukal Kewat	P	Ayush Rakesh Jharbade	
Anuja Sanjay Jiddewar	P	Ayush Ravi Patil	P
Apeksha Dnyaneshwar Dive		Bhavesh Vijay Madne	P
Arati Naththuji Chaudhari	P	Bobby Chamanlal Jagdeo	
Bhagyashri Kailash Raut		Jitendra Narendra Dhok	P
Diksha Dnyaneshwar Tembhurne	P	Kunal Sahdeo Jangde	
Divya Dilip Meshram	P	Lokesh Chandrashekhar Hiwarkar	P
Gouri Rajesh Chinkure		Lotus Anil Meshram	P
Grishma Rajesh Sakhare		Manoj Gangadhar Mamadge	
Himanshi Vijay Khot	P	Manoj Samelal Damahe	
Khushboo Eknath Lanjewar	P	Mohd Shahnawaz Salahuddin Ansari	P
Khushi Dipak Gawande		Mohd Soheli Mohd Mustak Ansari	P
Madhulika Sanjay Gajbhiye	P	Nayan Shriram Thakre	P
Madhura Bhaskar Lakhote		Prajwal Suresh Kamdi	
Minal Vilasrao Parkhad	P	Prathmesh Vilas Suhagpure	P
Mrunali Sanjaykumar Jambhulkar	P	Rajat Punaji Barapatre	
Neha Rupchand Dhargave		Saket Dilip Fulewar	P
Nilima Umesh Deotare		Samir Ashokrao Parate	P
Nimisha Shailendra Wankhede	P	Sanket Pandurang Talwekar	
Pallavi Vilas Nimgade	P	Sarang Suresh Sorte	
Pooja Shantaram Tayade		Saurabh Ranapratap Singh	P
Ruchita Shriram Rajurkar	P	Shantanu Dhanesh Rangari	P
Rutvika Ravishankar Chhapekar		Sidheshwar Vishawnath Khandare	P
Sahili Sanjay Bhowate		Sumit Manoj Thakur	
Samiksha Balkrushna Zamre		Swapnil Trimbak Pustode	
Saniya Nandlal Yadav	P	Swarnil Sunil Kokulwar	P
Shaily Purushottam Waje	P	Tanmay Ravindra Thombre	
Sharwari Baban Somkuwar	P	Tejas Ramchandra Kirpal	P



NAGPUR INSTITUTE OF TECHNOLOGY

(Affiliated to RTM Nagpur University & Approved by AICTE New Delhi)

CAMPUS: 13/2, Mahurzari, Near Fetri, Katol Road, Nagpur-441501, India

Email Id : registrar@nit.edu.in Web : www.nit.edu.in Contact No. 09764974144

RTMNUCollege Code: 315

DTE Code: 4144

AICTE ID :1-4830701

Department of Computer Science and Engineering

Session: 2022-23

Shivani Suresh Gaikwad		Tushar Nitin Sondowle	
Shruti Abhimanyu Patil	P	Vansh Mulidhar Padade	P
Trupti Sanjay Khobragade		Vedant Sunil Ghole	P
Aashutosh Sanjay Gawande	P	Vijay Bharat Pawar	
Aditya Kailashji Dakhane	P	Vinay Sanjay Nikose	P
Akash Subhash Shiv		Yugal Dulichand Bihune	
Ankit Kavadu Patil		Yugant Maroti Hate	P
Atharv Ashok Patil	P	Sakshi Kale	
List Of Present Students from 2nd year			
Adikane Shilpa Suryabhan		Jaunjal Vinayak Vasanta	
Bawangade Aditi Ajay	P	Khandekar Om Ramesh	P
Bhaisare Minal Baba	P	Kshirsagar Jay Raju	
Bhusari Divyani Nandkishor		Kshirsagar Sumit Sachin	
Bondre Sejal Ashok	P	Lamsonge Anshul Suresh	
Gajbhiye Srushti Rajendra		Lanjewar Ayush Ishwar	P
Gajshri Satyawar Bhosale	P	Madankar Chetan Sanjay	
Ghongade Anjali Pravin		Mendhe Abhay Ramesh	P
Gomase Payal Chandrashekhar	P	Meshram Advesh Avinash	
Kaithal Krutika Chandrakisor	P	Meshram Krish Ritesh	P
Kale Priyanka Pradeep		Meshram Pranay Bhagwan	
Kanchan Keshav Bembalge	P	Meshram Pratham Dilip	P
Khope Kalyani Suresh		Mohan Babarao Chaple	P
Mohatkar Karina Sudhakar	P	Moharana Jyotisman Himanshu	
Patil Twinkal Ravichandra		Moon Manas Vilas	
Rathod Vaishnavi Namdev	P	Moon Swayam Raju	
Ravina Rajesh Hedau	P	Nerkar Aniket Rajendra	P
Samarth Yogeshwari Arun	P	Nitnaware Shantanu Satish	
Santoshwar Pratiksha Prakash	P	Onkar Sanjay Padman	P
Shruti Anil Modak	P	Parihar Krunal Arunsingh	
Tagde Khushi Sanjay		Patange Abhishek Avdhutrao	P
Tarware Nainshee Rajesh	P	Pimpalkar Devashish Gopal	P



NAGPUR INSTITUTE OF TECHNOLOGY

(Affiliated to RTM Nagpur University & Approved by AICTE New Delhi)

CAMPUS: 13/2, Mahurzari, Near Fetri, Katol Road, Nagpur-441501, India

Email Id : registrar@nit.edu.in Web : www.nit.edu.in Contact No. 09764974144

RTMNUCollege Code: 315

DTE Code: 4144

AICTE ID :1-4830701

Department of Computer Science and Engineering

Session: 2022-23

Atharv Shankar Savalake	P	Raut Abhijeet Prashant	
Avishkar Sayaji Aher		Rohit Naresh Suryawanshi	P
Bargat Vansh Rameshwar	P	Satpute Vedant Kashinath	P
Basande Prajwal Pramod		Shegekar Gaurav Rajendra	
Chauhan Ninad Akhileshwar	P	Shingade Aditya Bhruthari	P
Chimankar Vivek Kewal		Shriwas Yash Kanhiyya	
Chinchamatpure Mayur Sanjay	P	Singh Shivam Shiv Kumar	P
Devanand Vilas Salunke	P	Tambuskar Bhavesh Shailesh	
Fulzele Shilwan Vilas	P	Tikhat Dhanraj Bandu	P
Gajbhiye Sujal Sunil	P	Uike Vivek Sharad	P
Golhar Prashant Gunwanta		Wadbudhe Pratham Balkrushna	P
Gondole Ayush Naresh		Wandile Vinit Babarao	
Gujarkar Ayush Shankar	P	Yelchalwar Onkar Anantrao	P
Janbandhu Anshul Jitendra	P	Yerekar Bhavesh Ramesh	

Prof. Mohammad Sajid
Event Coordinator

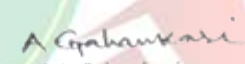
Prof. A. Gabankari
Head, CSE Deptt.

H.O.D.
Computer Science & Engineering Dept.
Nagpur Institute of Technology
Nagpur.



NAGPUR INSTITUTE OF TECHNOLOGY

(Affiliated to RTM Nagpur University & Approved by AICTE New Delhi)

CAMPUS: 13/2, Mahurzari, Near Fetri, Katol Road, Nagpur-441501, India

Email Id :registrar@nit.edu.in Web : www.nit.edu.in Contact No. 09764974144

RTMNUCollege Code: 315

DTE Code: 4144

AICTE ID :1-4830701

Department of Computer Science and Engineering

Session: 2022-23

Date: 8-04-2023

Notice

All the students of Third and Final semester are hereby informed that the, CSE Department is organizing 2 days Workshop on “**Networking and Cloud Computing**” is schedule on dated 11-04-2023 to 12-04-2023. All the students must be present at the mentioned venue & time below.

Venue: CSE Computer Lab

Prof. Mohammad Sajid
Event Coordinator

Dr. Shrikant Zade
Head, CSE Deptt.
H.O.D.
Computer Science & Engineering Dept.
Nagpur Institute of Technology
Nagpur.

Copy To:

1. Circulation in Class of VI, VIII Semester
2. Notice Board
3. Office File

Date: 12/4/2023



NAGPUR INSTITUTE OF TECHNOLOGY

(Affiliated to RTM Nagpur University & Approved by AICTE New Delhi)

CAMPUS: 13/2, Mahurzari, Near Fetri, Katol Road, Nagpur-441501, India

Email Id : registrar@nit.edu.in Web : www.nit.edu.in Contact No. 09764974144

RTMNUCollege Code: 315

DTE Code: 4144

AICTE ID :1-4830701

Department of Computer Science and Engineering

Session: 2022-23

Activity Report

Activity Title	:	Networking and Cloud Computing
Expert Detail	:	Mr.RajArora CEO, Revat Network, Nagpur
Date & Time	:	11 /04 /2023 To 12/4/2023, 12:00pm
Mode of Conduction	:	Offline
Participants	:	Student: 75 Faculty:02
Objective of program	:	To Make students aware about the Networking and Cloud Computing in the field of Engineering and Technology.
Program coordinator	:	Prof. Mohammad Sajid

The Department of Computer Science & Engineering have organized Networking and cloud computing program on “**Networking and Cloud Computing**” for the Students CSE of Nagpur Institute Of Technology, Nagpur Head of CSE Dr. ShrikantZade and total 75 students of CSE have attended the program .

Nagpur Institute of Technology



NAGPUR INSTITUTE OF TECHNOLOGY

(Affiliated to RTM Nagpur University & Approved by AICTE New Delhi)

CAMPUS: 13/2, Mahurzari, Near Fetri, Katol Road, Nagpur-441501, India

Email Id :registrar@nit.edu.in Web : www.nit.edu.in Contact No. 09764974144

RTMNUCollege Code: 315

DTE Code: 4144

AICTE ID :1-4830701

Department of Computer Science and Engineering

Session: 2022-23

Glimpses of the Event:



Prof. Mohammad Sajid
Event Coordinator

Dr. Shrikant Zade
Head, CSE Deptt.
H.O.D.
Computer Science & Engineering Dept.
Nagpur Institute of Technology
Nagpur.



NAGPUR INSTITUTE OF TECHNOLOGY

(Affiliated to RTM Nagpur University & Approved by AICTE New Delhi)

CAMPUS: 13/2, Mahurzari, Near Fetri, Katol Road, Nagpur-441501, India

Email Id :registrar@nit.edu.in Web : www.nit.edu.in Contact No. 09764974144

RTMNUCollege Code: 315

DTE Code: 4144

AICTE ID :1-4830701

Department of Computer Science and Engineering

Session: 2022-23

List Of Present Students from 4th (FINAL YEAR)

NAME OF STUDENTS		NAME OF STUDENTS	
Achal Sunil Sirsat	P	Balvesh Bastilal Puramkar	P
Ana Shamsu Sheikh		Durgesh Laxman Wajge	P
Avantika Vijay Gohane	P	Ganesh Arun Pandey	
Dipali Suresh Raut		Harshal Hitendra Uikey	P
Gaytri Gajanan Dandhare	P	Harshal Vinayak Burde	P
Hrunalika Raju Mauje	P	Harshvardhan Arunkumar Buddala	
Isha Namdeo Ganvir		Jaishankar Shravankumar Tripathi	P
Isha Vinod Patil	P	Laxmikant Moreshwar Anturkar	
Ishika Gopal Khutate		Manoj Duryodhan Shahare	
Janhavi Somaji Thul	P	Parag Kawaduji Gajbhiye	P
Kalyani Ramesh Dhole	P	Prashant Dindayal Katre	
Kalyani Tarachand Neware	P	Rakesh Subhash Sangode	P
Mayuri Ganesh Balapure		Sagar Rajesh Dongre	
Neha Gunesh Khandare		Sahil Hasmukh Meshram	
Nikita Rajendra Kale	P	Sanchet Vinod Manohare	P
Payal Hemraj Borkar		Sarang Ravindra Gajame	P
Prachi Ashok Gupta	P	Saurabh Wasudeo Chachere	P
Punam Puranchandra Bhendarkar	P	Saurav Dinesh Yadav	P
Purvi Rajesh Awaze		Shagun Sanjay Kingaonkar	
Reshma Banduji Khawse	P	Shivam Arvindrao Bhumbare	P
Riya Gajanan Bawane	P	Shrinivas Ulhas Chinchanikar	
Ruchi Mohan Rana		Shubham Digambar More	P
Sakshi Banduji Bhujade	P	Shubham Pramod Mirase	P
Sakshi Bhumeswar Thakre		Shubham Ramadhar Yadav	P
Smiksha Shivilal Tembhone		Sudhanshu Rajesh Akote	
Shriya Prakash Borkar		Sumit Raju Sundergiri	P
Shweta Manoj Tumne	P	Tejas Vasanta Bhajbhujje	P
Shweta Sanjay Riyal	P	Uddesh Rameshwar Piprewar	



NAGPUR INSTITUTE OF TECHNOLOGY

(Affiliated to RTM Nagpur University & Approved by AICTE New Delhi)

CAMPUS: 13/2, Mahurzari, Near Fetri, Katol Road, Nagpur-441501, India

Email Id : registrar@nit.edu.in Web : www.nit.edu.in Contact No. 09764974144

RTMNUCollege Code: 315

DTE Code: 4144

AICTE ID :1-4830701

Department of Computer Science and Engineering

Session: 2022-23

Sonali Yashwant Gadekar		Vishal Dilip Lamsoge	P
Tanu Sunilrao Gawande	P	Yash Sunil Lad	
Triveni Falgun Meshram	P	Rani Wanjari	P
Aditya Ghanshyam Kshirsagar	P		
Aditya Shivgovind Chauhan	P		
Ajinkya Anand Bawane			
Aman Anand Patil			
Ashish Moreshwar Pund	P		

List Of Present Students from 3rd year

NAME OF STUDENTS		NAME OF STUDENTS	
Achal Sukal Kewat	P	Ayush Rakesh Jharbade	P
Anuja Sanjay Jiddewar		Ayush Ravi Patil	
Apeksha Dnyaneshwar Dive	P	Bhavesh Vijay Madne	P
Arati Natthuji Chaudhari		Bobby Chamanlal Jagdeo	
Bhagyashri Kailash Raut	P	Jitendra Narendra Dhok	P
Diksha Dnyaneshwar Tembhurne		Kunal Sahdeo Jangde	
Divya Dilip Meshram	P	Lokesh Chandrashekhar Hiwarkar	P
Gouri Rajesh Chinkure	P	Lotus Anil Meshram	P
Grishma Rajesh Sakhare	P	Manoj Gangadhar Mamadge	P
Himanshi Vijay Khot		Manoj Samelal Damahe	
Khushboo Eknath Lanjewar		Mohd Shahnawaz Salahuddin Ansari	P
Khushi Dipak Gawande	P	Mohd Soheli Mohd Mustak Ansari	P
Madhulika Sanjay Gajbhiye		Nayan Shriram Thakre	
Madhura Bhaskar Lakhote	P	Prajwal Suresh Kamdi	P
Minal Vilasrao Parkhad		Prathmesh Vilas Suhagpure	
Mrunali Sanjaykumar Jambhulkar	P	Rajat Punaji Barapatre	
Neha Rupchand Dhargave	P	Saket Dilip Fulewar	P
Nilima Umesh Deotare		Samir Ashokrao Parate	



NAGPUR INSTITUTE OF TECHNOLOGY

(Affiliated to RTM Nagpur University & Approved by AICTE New Delhi)

CAMPUS: 13/2, Mahurzari, Near Fetri, Katol Road, Nagpur-441501, India

Email Id : registrar@nit.edu.in Web : www.nit.edu.in Contact No. 09764974144

RTMNUCollege Code: 315

DTE Code: 4144

AICTE ID :1-4830701

Department of Computer Science and Engineering

Session: 2022-23

Nimisha Shailendra Wankhede		Sanket Pandurang Talwekar	P
Pallavi Vilas Nimgade	P	Sarang Suresh Sorte	
Pooja Shantaram Tayade	P	Saurabh Ranapratap Singh	P
Ruchita Shriram Rajurkar		Shantanu Dhanesh Rangari	
Rutvika Ravishankar Chhapekar	P	Sidheshwar Vishawnath Khandare	P
Sahili Sanjay Bhowate		Sumit Manoj Thakur	
Samiksha Balkrushna Zamre		Swapnil Trimbak Pustode	P
Saniya Nandlal Yadav	P	Swarnil Sunil Kokulwar	P
Shaily Purushottam Waje		Tanmay Ravindra Thombre	
Sharwari Baban Somkuwar	P	Tejas Ramchandra Kirpal	P
Shivani Suresh Gaikwad		Tushar Nitin Sondowle	
Shruti Abhimanyu Patil	P	Vansh Mulidhar Padade	P
Trupti Sanjay Khobragade		Vedant Sunil Ghole	
Aashutosh Sanjay Gawande	P	Vijay Bharat Pawar	P
Aditya Kailashji Dakhane	P	Vinay Sanjay Nikose	P
Akash Subhash Shiv		Yugal Dulichand Bihune	
Ankit Kavadu Patil		Yugant Maroti Hate	
Atharv Ashok Patil	P	Sakshi Kale	

Prof. Mohammad Sajid
Event Coordinator

Dr. Shrikant Zade
Head, CSE Deptt.
H.O.D.
Computer Science & Engineering Dept.
Nagpur Institute of Technology
Nagpur.



NAGPUR INSTITUTE OF TECHNOLOGY

(Affiliated to RTM Nagpur University & Approved by AICTE New Delhi)

CAMPUS: 13/2, Mahurzari, Near Fetri, Katol Road, Nagpur-441501, India

Email Id: registrar@nit.edu.in Web: www.nit.edu.in Contact No. 09764974144

RTMNU College Code: 315

DTE Code: 4144

AICTE ID : 1-4830701

5.1.2 Following capacity development and skills enhancement activities are organized for improving students' capability in 2021-22

4.Awareness of trends in technology

SN	Name of the capacity development and skills enhancement program	Period (from date - to date)	Number of students enrolled	Name of the agencies/experts involved with contact details
1	3 Days workshop on current trends in AutoCAD, BIM with Revit Architect structural Analysis & Design with Stadd Pro	05-05-2022 to 07-05-2022	80	Ms. Ketki Meshram, CADD Centre, Nagpur
2	2 days online workshop on latest trends in Innovation & Entrepreneurship	18-06-2022 to 19-06-2022	155	Prof. Vipin Khangar in association with MiC-IIC under Impact Lecture Series
3	02 Days workshop on CNC Part Programmin	12-04-2022 to 13-04-2022	39	Prof. D P Gulhane & in association with IGTR Nagpur
4	2 Days Workshop on Simulation of Electrical and Electronics Circuits on Proteus	02-03-2022 to 03-03-2022	26	Mr. Sarang Shastrakar, Director, Electro-Automation , Nagpur.
5	2 Days Workshop on Trends in Electrical System Design	14-04-2022 to 15-04-2022	34	Mr Akshay Jain, Corporate trainer, EE Center Head Live wire, Nagpur.



PRINCIPAL
Nagpur Institute of Technology,
Nagpur - 441501.



Date: 07-09-2019

NOTICE

Department of civil Engineering organizing Seminar on 3 days online workshop on the topic "AutoCAD 2D, BIM with Revit Architects Structural Analysis and Design with STAAD.Pro" for the students of Second year, Third year and Final year. All are informed to be remain present on 05-05-2022 , 06-05-2022 and 07-05-2022 in Zoom.

Prof. Rohit Bhosle
Co-ordinator workshop

Prof. Sudhir Kapgate
HOD Civil Engg.

Head of Department
Civil Engineering
Nagpur Institute of Technology
Nagpur

Copy To:

- 1) Principal
- 2) HOD CE
- 3) Class incharge 2nd Year
- 4) Class incharge 3rd Year



Date: - 10-05-2022

3 Days Workshop Report

Civil Engineering Department, organized 3 days online workshop under forum of Civil Engineering Students Association (CESA) on the topic **“AutoCAD 2D, BIM with Revit Architects Structural Analysis and Design with STAAD.Pro”** on dated 05-05-2022 , 06-05-2022 and 07-05-2022 as Internal Quality Assurance Cell (IQAC) initiatives. **Ms. Ketki Meshram, CADD Centre, Nagpur** was invited to deliver the lecture through online mode. **Ms. Ketki Meshram** successfully conducted the session with power point presentation and shared his experiences and views on the the how you can make your careers in Building Drafting, Modeling and Analysis with various Software's to enhance knowledge and skills. The complete guidance seminar was for core and noncore students.

Day 1: AutoCAD 2D: Complete Course for Beginners

Day 2: BIM with Revit Architects and

Day 3: Structural Analysis and Design with STAAD.pro.

Opening remark was delivered by Prof. Sudhir Kapgate, HOD, Civil Engineering Department, NIT, Nagpur. Total 100 students were present for attending the Workshop on Zoom App and 80 students were attending on YouTube Live. Finally the session was ended by Prof. Rohit Bhosle with vote of thanks. The workshop was successfully coordinated by Prof. Rohit Bhosle and entire Civil Engineering department and also Civil Engineering team worked hard to make the program a grand success.

Glimpse of the Workshop:

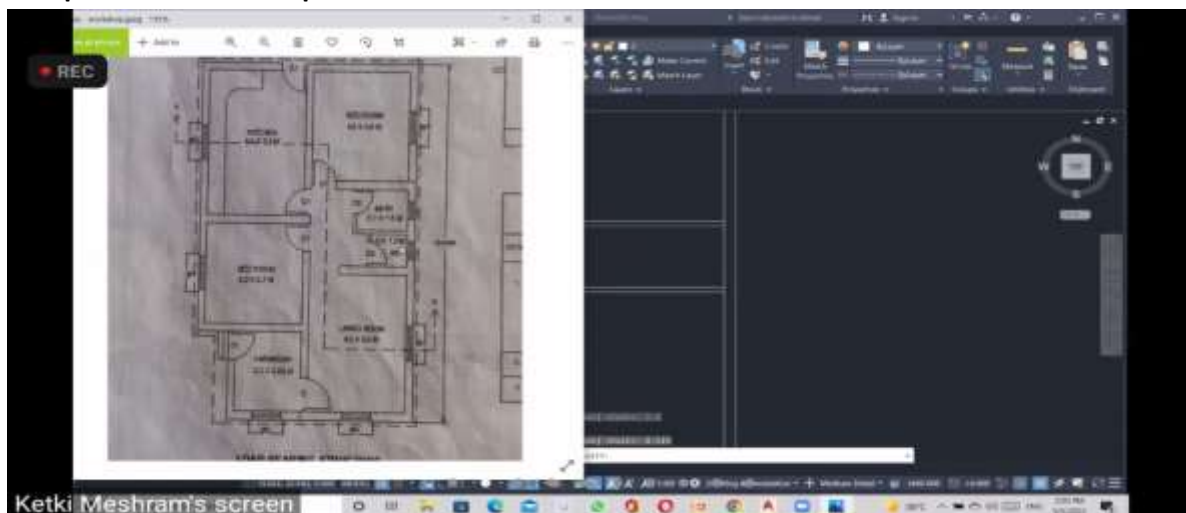



ShriSaiShikshanSanstha's
NAGPUR INSTITUTE OF TECHNOLOGY, NAGPUR
 Survey No.13/2, Mahurzari, Near Fetri, Katol Road Nagpur-441501
 Email: info@nit.edu.in, Tel: 08275010512, 08275010559
 Session 2021-22
 Department of Civil Engineering



**Shri Sai Shikshan Sanstha's
Nagpur Institute of Technology**

CADD CENTRE NAGPUR
 In Association with
Department of Civil Engineering
 Organizes Three days online workshop on
"AutoCAD 2D, BIM with Revit Architects Structural Analysis and Design with STAAD. Pro"
 As An Internal Quality Assurance Cell (IQAC) Initiatives
 Under the Banner of CESA Forum.

Resource Persons
 Ms. Keeki Meshram
 CADD Centre,
 Nagpur

Provided By
 Dr Amul Deshmukh
 Principal
 NIT, Nagpur

Module - 1 on 5th May 2022: AutoCAD 2D: Complete Course for Engineers
 Module - 2 on 6th May 2022: BIM with Revit Architects
 Module - 3 on 7th May 2022: Structural Analysis and Design with STAAD. Pro

Join Zoom Meeting
 Meeting ID: 905 2499 3387

05 May 2022 to 07 May 2022
01:00 PM - 2:00 PM
 A Certificate will be provided to all participants.

REGISTER ONLINE OR SCAN CODE FOR REGISTRATION
<https://www.nitnagpur.ac.in/qaac/qaac.html>

Prof. Sudhir S. Kapgate
 Head Department of Civil Engineering
 NIT, Nagpur.

Prof. Rohit N. Bhosle
 Exec. Coordinator
 NIT, Nagpur.

" QUEST FOR EXCELLENCE "

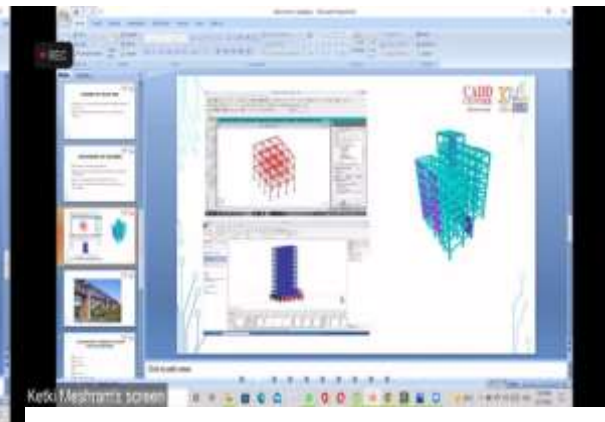
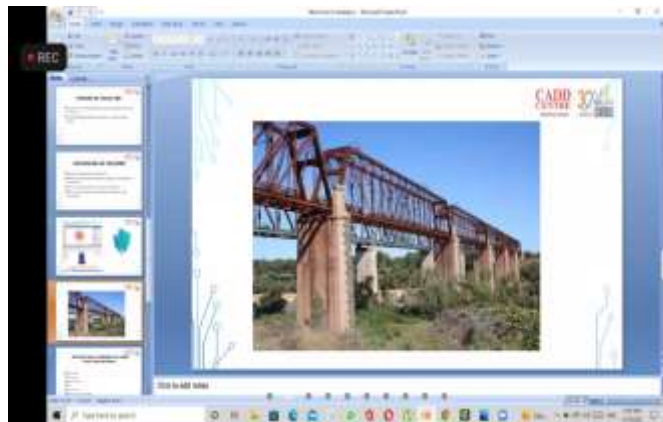

Prof. Rohit Bhosle
 (Co-ordinator)

Prof. Sudhir Kapgate
 (HOD, Civil Engg.Dept.)
**Head of Department
 Civil Engineering
 Nagpur Institute of Technology
 Nagpur**



Shri Sai Shikshan Sanstha's
NAGPUR INSTITUTE OF TECHNOLOGY, NAGPUR
Survey No.13/2, Mahurzari, Near Fetri, Katol Road Nagpur-441501
Email: info@nit.edu.in, Tel: 08275010512, 08275010559
Session 2021-22
Department of Civil Engineering



Name of the Activity :- "AutoCAD 2D, BIM with Revit Architects Structural Analysis and Design with STAAD.Pro"

Activity Attendance Sheet Eighth Semester

Date :- 05-05-2022, 06-05-2022 & 07-05-2022

Roll No.	Name of Student	Att	Roll No.	Name of Student	Att
401	ALISHA ANIL JAWADE	P	434	DANISH GOUS BAIG	
402	ASHWINI SUDHIR SELUKAR	P	435	DHANANJAY A MANKAWDE	
403	DIVYANI ARVIND TRIPATHI	P	436	GOURAV V MELEKAR	P
404	KIRTI ANIL RATHOD	P	437	HARSHAL SURESH LANGDE	P
405	MANASVI KISHOR DONGRE	P	438	JULFEKAR AHMAD ANSARI	
406	MAYURI BALIRAM SHIVARKAR	P	439	KHAN MOHSIN M AHMAD	P
407	MAYURI WAMAN UKEY		440	KSHITIJ TARACHAND SHAHU	
408	NALINI SUSHIL NAGPURE	P	441	MANOJ MAHADEV SUPEKAR	P
409	NIKITA BHASKAR JUARE	P	442	MOHAMMAD GHAYYUR	
410	PALLAVI PRAKASH JADHAV		443	NAWAL RAJESH SAWAYYA	P
411	PRADHNYA M WANKHEDE	P	444	NIKHIL PRAKASH KHADGI	P
412	PRAGATI PRAVINRAOJI ALONE		445	NILESH KAILASH GAYDHANE	
413	PRANJU SANDEEP NAGDEVTE	P	446	PAPPU UMESH PANDEY	P
414	PRERNA KAILASNATH SHINDE	P	447	PORAS SURENDRA KAWALE	
415	RASHMI SHENDE		448	PRAJWAL R DESHMUKH	P
416	RUCHIKA DIPAK GAJBHIYE	P	449	PRAMOD PANDHARI THAKARE	
417	SAKSHI VIRENDRA NIMKAR	P	450	PRANEET VINAYAK DETHE	P
418	SHEEVANI GAJANAN TAKIT		451	PRATIK RAVINDRA MESHRAM	
419	SHILPA ARUN SELOKAR	P	452	RACHIT RAVINDRA PATIL	P
420	SHIVANI DEVANAND SAHARE	P	453	RAHUL CHANDULAL PARTEKI	
421	SHIVANI WASUDEV CHACHERE		454	RAHUL RAMESH BARAPATRE	P
422	SHRADHA JAGDISH BAGDE	P	455	RAJ NARESH BHOSLE	
423	SHRUTI WAMAN SAHARE	P	456	RAJ RAJU PANDIT	P
424	TEJASWINI B MARASKOLHE	P	457	RAJAT VASANTA BHOYAR	
425	VAISHNAVI ASHOK CHHATRE		458	RAMAN GYANDAS SAHARE	P
426	VAISHNAVI K WELEKAR	P	459	ROHIT RAJU UMREDKAR	
427	VARSHA AMARLAL AMODE		460	RUSHABH P. BADWAIK	P
428	ADESH SURESH WADHAI		461	RUSHIKESH P AMBHURKAR	
429	AKASHDEEP VINOD TAGADE	P	462	SANDESH SUDHIR JAMGADE	
430	ALI JAVED HAJI QYUM		463	SHAHBAZ ABDUL RASID SHEIKH	



ShriSaiShikshanSanstha's
NAGPUR INSTITUTE OF TECHNOLOGY, NAGPUR
Survey No.13/2, Mahurzari, Near Fetri, Katol Road Nagpur-441501
Email: info@nit.edu.in, Tel: 08275010512, 08275010559
Session 2021-22
Department of Civil Engineering



431	ALISHAN HAIDER ALI KHAN	
432	ASHIK NARHARIJI MANDPE	
433	AVINASH SURESH RASURE	

464	SHARAD D SHAMBHARKAR	
465	SHUBHAM B SONAWANE	

Prof. Rohit Bhosle
(Co-ordinator)

Prof. Sudhir Kagate
(HOD, Civil Engg.Dept.)

Head of Department
Civil Engineering
Nagpur Institute of Technology
Nagpur



Date: 27/7/2021

NOTICE

Mechanical Engineering Department is organizing Seminar on “Webinar on Awareness to MSMEs for Transition from Single use Plastic to Alternative Materials by Dr. Biswajit Ruj” of expert Dr. Biswajit Ruj Head & Senior Principal Scientist , (Environmental Engineering Group of CSIR-CMERI, Durgapur). All are informed to be present on 28/7/2021.

Prof. Vipin Khangar
Coordinator

Dr. N K Mandavgade
HoD

Copy To:

Class Incharge 2nd, 3rd & 4th Year

HOD, ME



Date: 29/07/2021

Webinar Report

Session	:	2021-2022
Department	:	Mechanical Engineering
Topic	:	Awareness to MSMEs for Transition from Single use Plastic to Alternative Materials
Date & Time of interaction	:	28 Jul 2021 @ 12:00 PM
Name of Expert	:	Dr. Biswajit Ruj, Head & Senior Principal Scientist
Name of organization	:	Environmental Engineering Group of CSIR-CMERI, Durgapur
No of participated	:	168
Coordinators	:	Prof V S Khangar
Objective of Webinar	:	Awareness program for Transition from Single use Plastic to Alternative Materials.

Event Details:

Nagpur Institute of Technology in association with MSME-DI Nagpur organized a Webinar on Awareness to MSMEs for Transition from Single use Plastic to Alternative Materials. Mr. Rahul Mishra , Asst Director MSME-DI given brief about event. Expert Speaker was Dr. Biswajit Ruj Head & Senior Principal Scientist from Environmental Engineering Group of CSIR-CMERI, Durgapur.

Dr. Amol Deshmukh given opening remark & Vote of thanks. Event was coordinated by Prof Vipin Khangar



Photographs of Webinar :



Shri Sai Shikshan Sanstha's
Nagpur Institute of Technology
 As an Institutional Innovation Council (IIC) initiative

In association with
Micro, Small & Medium Enterprises (MSME-DI), Nagpur
 Organizing
Sambhav
National level Awareness Program on Entrepreneurship

Chief Guest	Presided by	Guest of Honor
Shri. P. M. Parlewar Director MSME-DI, Nagpur	Dr. A. V. Deshmukh, Principal Nagpur Institute of Technology, Nagpur.	Shri. Rahul Mishra, Asst. Director MSME-DI, Nagpur

• Registration Link:- <https://forms.gle/kAer00JukPNJaDQz7>
 • Feedback form:- <https://forms.gle/mmn0Tvk1TenKRSDKs>
 (feedback is compulsory from every participant to receive e-certificate)

Nov 24, 2021
Time: 11.00 AM

Event Link:- meet.google.com/vsw-rwbc-ebc

Coordinator:
 Mr. Vipin Khangar
 III Cell Incharge
 Campus: Survey No. 13/2, Katol Road, Near Fetri, Mahurzari,
 Nagpur, Maharashtra 441501

Prof. Vipin Khangar
 Coordinator

Dr. N K Mandavgade
 HoD



III SEM

Roll No.	NAME OF STUDENT	Attendance	Roll No.	NAME OF STUDENT	Attendance
201	Payal Krushnaji Lokhande	P	234	Saurabh Omkar Kaurati	P
202	Pranali Ravindra Meshram	P	235	Savin Surjuse	P
203	Priyanka Tumlam	P	236	Shantanu Gajanan Hargode	P
204	Rajshi Anklesh Indurkar	P	237	Sumit Bhawarkar	P
205	Sagar Nepal Chamlate	P	238	Sumit Kumar Yadav	P
206	Sanskruiti Chokhandre	P	239	Swapnil Ashok Khonde	P
207	Shravani Dinesh Kadu	P	240	Ujwal Satish Lakhde	P
208	Tusharika Mahalle	P	241	Vaibhav Bhimrao Kusram	P
209	Abhishek Manoj Kumar Singh Solanki	P	242	Vinay Arkilla	P
210	Aditya Jagannath Kelwade	P	243	Yash Athod	P
211	Aman Ansari	P	244	Yash Kumre	P
212	Amar Adnyan Pendram	P	245	Abhilash Bharat Murar	P
213	Amin Mammusabu Pathan	P	246	Abhishek Narayan Sakharkar	P
214	Aniruddha Sonekar	P	247	Adarsh Natthuji Dhunde	P
215	Anush Uttamkumar Petkar	P	248	Aditya Vijayrao Boratkar	P
216	Ayush Yadav	P	249	Akash Kundlik Mene	P
217	Ayush Nandu Ganvir	P	250	Akash Maroti Shendre	P
218	Ganesh Sudam Raut	P	251	Aniruddh Laxman Sonkamble	P
219	Gaurav Gajanan Khanderao	P	252	Ankush Ganesh Chaudhary	P
220	Harshal Shravan Zade	P	253	Anurag Anil Ratnaparkhi	P
221	Ishant Harish Lokhande	P	254	Gaurav Rajeram Diwate	P
222	Kunal Madhukar Wasnik	P	255	Khan Mohd Fuzail Feroz	P



Shri Sai Shikshan Sanstha's
NAGPUR INSTITUTE OF TECHNOLOGY, NAGPUR
Survey No.13/2, Mahurzari, Near Fetri, Katol Road Nagpur-441501



223	Mahesh Vinod Dhapke	P	256	Nikhil Devendra Nimje	P
224	Jitesh Munjewar	P	257	Piyush Bhagwat Tadose	P
225	Piyush Mahadeo Nikode	P	258	Piyush Umesh Puri	P

Prof. Vipin Khangar
Coordinator

Dr. N K Mandavgade
HoD



Shri Sai Shikshan Sanstha's
NAGPUR INSTITUTE OF TECHNOLOGY, NAGPUR
Survey No.13/2, Mahurzari, Near Fetri, Katol Road Nagpur-441501



V SEM

Roll No.	NAME OF STUDENT	Attendance	Roll No.	NAME OF STUDENT	Attendance
1	Akanksha Dhadel	P	48	Kaushik Kotangle	P
2	Anjali Khobragade	P	49	Krunal Gautam Patil	P
3	Bhavana Sunderlal Nandanwar	P	50	Kshitij Nikose	P
4	Bhawana Taywade	P	51	Mukesh Ram Kumbhare	P
5	Damini Prachi	P	52	Nikhil Ambadas Kotjawale	P
6	Himanshi Barsagade	P	53	Nikhil Kailash Sukhdeve	P
7	Ishika Rathod	P	54	Nimesh Durgesh Suryawanshi	P
8	Kanchan Balkrishna Tembhurne	P	55	Praful Ashok Ram	P
9	Koyal Hingwe	P	56	Prajwal Chandrashekhar Khidkikar	P
10	Neha Bodhe	P	57	Prajwal Tayawade	P
11	Nutan Babarao Mandale	P	58	Prajwal Manerao	P
12	Shital Prabhakar Nikose	P	59	Prajwal Deochand Jungade	P
13	Swati Suresh Khorgade	P	60	Prajwal Kandalkar	P
14	Utkarsha Pathade	P	61	Pratik Raju Mate	P
15	Vaishnavi Bitne	P	62	Pratik Vasant Dhumal	P
16	Abdul Talib Abdul Waris	P	63	Pratikkumar Devendra Gajbhiye	P
17	Abhijit Ramesh Wahane	P	64	Rajsingh Thakur	P
18	Abhishek Meshram	P	65	Rishikesh Pravin Kitke	P
19	Abhishek Pramodraoji Kakde	P	66	Ritesh Jitendra Nikose	P
20	Abhishek Sanjayraoji Umale	P	67	Ritesh Mangtani	P
21	Adarsh Raut	P	68	Ritesh Chatap	P
22	Ajay Chandrakant Parate	P	69	Ritik Deepak Gajbhiye	P
23	Ajinkya Pramod Labhshetwar	P	70	Sagar Shambharkar	P



Shri Sai Shikshan Sanstha's
NAGPUR INSTITUTE OF TECHNOLOGY, NAGPUR
Survey No.13/2, Mahurzari, Near Fetri, Katol Road Nagpur-441501



24	Ajinkya Meshram	P	71	Saharsh Waghmare	P
25	Akash Gholse	P	72	Saksham Sukhadeve	P
26	Aniket Rajesh Shegokar	P	73	Sanjay Amrut Damahe	P
27	Aniket Subhakar Nikose	P	74	Sanket Yewale	P
28	Ankit Khobragade	P	75	Saurabh Vijaysingh Thakur	P
29	Arpit Wankhede	P	76	Shreyash Singh	P
30	Ashish Vinayak Lokhande	P	77	Shubham Buddheshwar Patil	P
31	Avesh Khan Arif Khan Pathan	P	78	Sumet Yuvraj Borkar	P
32	Faizan Khan Ayan Khan	P	79	Sumit Shankar Momte	P
33	Gaurav Jagdishrao Bhange	P	80	Sumit Suresh Kolhe	P

Prof. Vipin Khangar
Coordinator

Dr. N K Mandavgade
HoD



Shri Sai Shikshan Sanstha's
NAGPUR INSTITUTE OF TECHNOLOGY, NAGPUR
Survey No.13/2, Mahurzari, Near Fetri, Katol Road Nagpur-441501



VII SEM

Roll No.	NAME OF STUDENT	Attendance	Roll No.	NAME OF STUDENT	Attendance
1	Anaya Pritkumar Bansod	P	50	Palash Rajesh Karade	P
2	Ankita Keshavrao Gajbe	P	51	Parvez Sheikh	P
3	Dhanashri Suresh Bhagwatkar	P	52	Pranay Guneshwar Bagde	P
4	Manisha Ratansinh Suryawanshi	P	53	Pranay Ramrao Thakre	P
5	Meenakshi Shankar Kounder	P	54	Pratik Shingney	P
6	Pooja Deepak Tirpude	P	55	Pritam Durgadasji Bagde	P
7	Ranjana Umakant Barapatre	P	56	Rahul Bhagwandas Baraiyya	P
8	Rutika Dewaji Gotmare	P	57	Rajat Ratanlal Kamble	P
9	Sonal Arunrao Badode	P	58	Rishi Kumar Choudhary	P
10	Sonali Kamlakar Dhande	P	59	Ritesh Sampat Ukey	P
11	Sujata Diliprao Barai	P	60	Ritesh Sanjay Choudhari	P
12	Vaishnavi Bhagwat Chirwatkar	P	61	Ritik Sonkambale	P
13	Akash Khadikar	P	62	Rohan Narayanrao Marotkar	P
14	Abhijeet Mahendra Deodhagale	P	63	Rohit H. Meshram	P
15	Ahmed Raza Afsar Khan	P	64	Roshan Gayakwad	P
16	Akshay Waghmare	P	65	Roshan Hemraj Umate	P
17	Amit Ravindra Bele	P	66	Roshan Sharad Babhulkar	P
18	Aniket Jyotish Wat	P	67	Sachin Gulabrao Bokde	P
19	Aniket Kumar Singh	P	68	Sahil Sureshrao Nighot	P
20	Ankit Saroj Bobade	P	69	Saurabh Ashok Meshram	P
21	Ashik Gulab Gaydhane	P	70	Saurabh Dinesh Neware	P
22	Ashish Gujwar	P	71	Saurabh Rewatkar	P
23	Ashish Sahankar Shirodiye	P	72	Saurabh Lolusare	P



Shri Sai Shikshan Sanstha's
NAGPUR INSTITUTE OF TECHNOLOGY, NAGPUR
Survey No.13/2, Mahurzari, Near Fetri, Katol Road Nagpur-441501



24	Badal Ravindra Bawankule	P	73	Nehal Shahadat Ali Sayyad	P
25	Bhavesh Sewatkar	P	74	Shantanu Satishrao Wankhede	P
26	Chakradhar Bhimrao Khandekar	P	75	Shashank Anil Kanholkar	P

Prof. Vipin Khangar
Coordinator

Dr. N K Mandavgade
HoD



Shri Sai Shikshan Sanstha's
NAGPUR INSTITUTE OF TECHNOLOGY, NAGPUR
Survey No.13/2, Mahurzari, Near Fetri, Katol Road Nagpur-441501
Department of Mechanical Engineering



Date: 08/4/2022

NOTICE

Mechanical Engineering Department is organizing workshop on “CNC programming” in association with Indo German Tool Room, Nagpur. All are informed to be present on 12/04/2022 to 13/04/2022.

Prof. Vipin Khangar
Coordinator

Dr. N K Mandavgade
HoD

Copy To:

Class Incharge 3rd & 4th Year
HOD, ME



Shri Sai Shikshan Sanstha's
NAGPUR INSTITUTE OF TECHNOLOGY, NAGPUR
Survey No.13/2, Mahurzari, Near Fetri, Katol Road Nagpur-441501
Department of Mechanical Engineering



Date: 13/04/2022

Webinar Report

Session : 2021-2022
Department : Mechanical Engineering
Topic : " CNC programming"
Date & Time of interaction : 12/04/2022 To 13/04/2022 @ 10:00 AM
Name of Expert : Mr. Imranul Haq
Name of organization : Indo German Tool Room, Nagpur
No of Staff participated : 39
Coordinators : Prof . D. P. Gulhane

Event Details:

Mechanical Engineering organized two days workshop on CNC programming in association with Indo German Tool Room, Nagpur centre on 12/04/22 & 13/04/22. Total 39 students registered for the program. Mr. Imranul Haq Incharge of Nagpur centre along with two other trainers will be giving hands-on practice to students. Dr. Nitin K. Mandavgade head mechanical delivered opening remarks. Dr. A. Y.Deshmukh delivered presidential address . The vote of thanks was given by Prof . Dipak Gulhane. The program was coordinated by Dr. V.N.Kalbande and prof Dipak Gulhane.

Photographs of Webinar :



Prof. Vipin Khangar
Coordinator

Dr. N K Mandavgade
HoD



Shri Sai Shikshan Sanstha's
NAGPUR INSTITUTE OF TECHNOLOGY, NAGPUR
Survey No.13/2, Mahurzari, Near Fetri, Katol Road Nagpur-441501
Department of Mechanical Engineering



V SEM

Roll No.	NAME OF STUDENT	Attendance	Roll No.	NAME OF STUDENT	Attendance
1	Akanksha Dhadel	P	48	Kaushik Kotangle	P
2	Anjali Khobragade	P	49	Krunal Gautam Patil	P
3	Bhavana Sunderlal Nandanwar	P	50	Kshitij Nikose	P
4	Bhawana Taywade	P	51	Mukesh Ram Kumbhare	P
5	Damini Prachi	P	52	Nikhil Ambadas Kotjawale	P
6	Himanshi Barsagade	P	53	Nikhil Kailash Sukhdeve	P
7	Ishika Rathod	P	54	Nimesh Durgesh Suryawanshi	P
8	Kanchan Balkrishna Tembhurne	P	55	Prafful Ashok Ram	P
9	Koyal Hingwe	P	56	Prajwal Chandrashekhar Khidkikar	P
10	Neha Bodhe	P	57	Prajwal Tayawade	P
11	Nutan Babarao Mandale	P	58	Prajwal Manerao	P
12	Shital Prabhakar Nikose	P	59	Prajwal Deochand Jungade	P
13	Swati Suresh Khorgade	P	60	Prajwal Kandalkar	P
14	Utkarsha Pathade	P	61	Pratik Raju Mate	P
15	Vaishnavi Bitne	P	62	Pratik Vasant Dhumal	P
16	Abdul Talib Abdul Waris	P	63	Pratikkumar Devendra Gajbhiye	P
17	Abhijit Ramesh Wahane	P	64	Rajsingh Thakur	P
18	Abhishek Meshram	P	65	Rishikesh Pravin Kitke	P
19	Abhishek Pramodraoji Kakde	P	66	Ritesh Jitendra Nikose	P

Prof. Vipin Khangar
Coordinator

Dr. N K Mandavgade
HoD



SHRI SAI SHIKSHAN SANSTHA'S
NAGPUR INSTITUTE OF TECHNOLOGY, NAGPUR
(Approved By AICTE New Delhi & DTE Mumbai(Govt.Of Maharashtra and Affiliated To
Rashtrasant Tukadoji Maharaj NagpurUniversity,Nagpur)
Campus: Survey No.13/2 ,Mahurzari , Near Fetri , Katol Road , Nagpur-441501(INDIA)

Department of Electrical Engineering

Session 2021-22 Notice/Circular

Date:28/02/2022

All the students of Electrical Engineering are hereby informed that the Department of Electrical Engineering is organizing the 2 days online workshop on “Simulation of Electrical and Electronics Circuits on Proteus,” on 02-03-2022 to 03-03-2022. The students of third year and final year of Electrical Engineering should attend and actively participate in the event.

Prof. R. V. Lonare
Coordinator

Dr. J. G. Chadhuri
HoD, Electrical



H. O. D.
Department of Electrical Engg.
Nagpur Institute of Technology

Copy To:

The Principal, NIT, Nagpur
The Dean(Academics), NIT, Nagpur



SHRI SAI SHIKSHAN SANSTHA'S
NAGPUR INSTITUTE OF TECHNOLOGY, NAGPUR
(Approved By AICTE New Delhi & DTE Mumbai(Govt.Of Maharashtra and Affiliated To
Rashtrasant Tukadoji Maharaj NagpurUniversity,Nagpur)
Campus: Survey No.13/2 ,Mahurzari , Near Fetri , Katol Road , Nagpur-441501(INDIA)

Department of Electrical Engineering

Session 2021-22
Activity Report

Date: 03/03/2022

Name of Program – 2 days Workshop on Simulation of Electrical and Electronics Circuits on Proteus.

Name of Department- Electrical Engineering

Name of organization- Electro-Automation, Nagpur

Name of activity – Workshop

Venue: Nagpur Institute of Engineering, Nagpur.

Date of event- 02-03-2022 to 03-03-2022

Event description

Forum (Feeder) of the Electrical Engineering Department organized a 2b days On;ine Workshop on Simulation of Electrical and Electronics Circuits on Proteus on 02-03-2022 to 03-03-2022. Expert was Mr. Sarang Shastrakar, Director, Electro-Automation , Nagpur. The overall workshop was coordinated by Prof. R. V. Lonare and team EE.

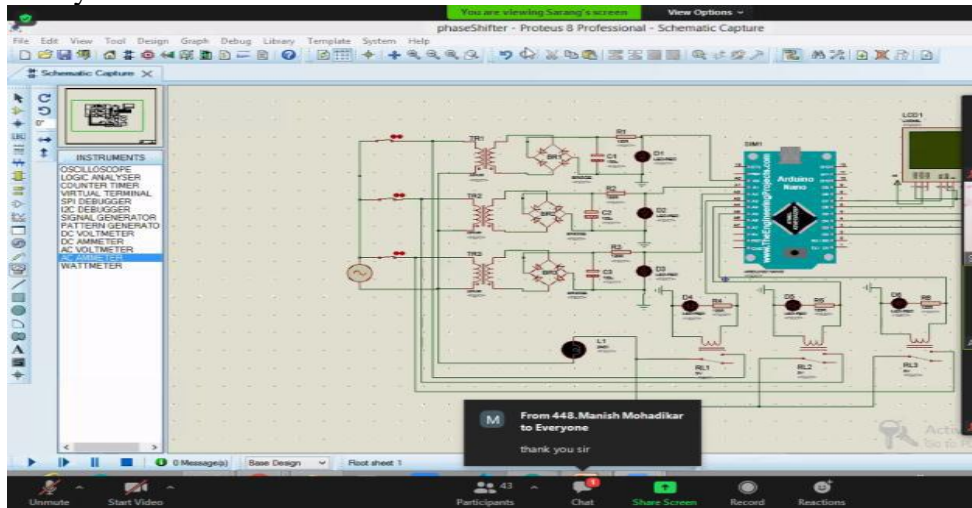

Prof. R. V. Lonare
Coordinator

Dr. J. G. Chadhuri

HoD, Electrical

H. O. D.

Department of Electrical Engg.
Nagpur Institute of Techonology

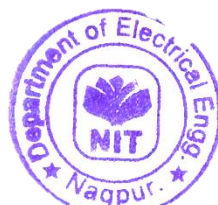



SHRI SAI SHIKSHAN SANSTHA'S
NAGPUR INSTITUTE OF TECHNOLOGY, NAGPUR
(Approved By AICTE New Delhi & DTE Mumbai(Govt.Of Maharashtra and Affiliated To
Rashtrasant Tukadoji Maharaj Nagpur University, Nagpur)
Campus: Survey No.13/2 ,Mahurzari , Near Fetri , Katol Road , Nagpur-441501(INDIA)

Department of Electrical Engineering

Session 2021-22

Date:-03/03/2022

Activity Attendance Sheet

Topic: - 2 days Workshop on Simulation of Electrical and Electronics Circuits on Proteus.
Expert Name & Designation: Mr. Sarang Shastrakar, Director, Electro-Automation , Nagpur
Year: - Final Year

Roll No	Name of Student	Day 1	Day 2
EE_402	ANKITA WASUDEO PARATE	P	P
EE_403	ASHWINI SUDHAKAR GAURKHEDE	P	P
EE_404	BHARTI VIJAY INGALE	P	P
EE_405	DIKSHA BAPURAO PATIL	P	P
EE_406	DIKSHA LAXMAN GAUTRE	P	P
EE_408	GAYATRI HARICHAND CHOPADE	P	P
EE_409	ISHA DEEPAK MESHARAM	P	P
EE_410	ISHITA MANOJ JUMDE	P	P
EE_411	KHUSHBOO GANESH LADHE	P	P
EE_412	KHUSHBOO SHIVAJI BAGDE	P	P
EE_414	MAYURI CHANRABHAN PAL	P	P
EE_415	NIKITA CHIRKUT NITNAVRE	P	P
EE_416	POOJA ANILRAO DHOLE	P	P
EE_417	PRACHI GANESH SONSARE	P	P
EE_418	PRACHI MADHUKAR MESHRAM	P	P
EE_419	RAKHI MAROTI BAGDE	P	P
EE_420	RAKHI RAMAJI KURMATE	P	P
EE_421	RAVINA ASHOK UIKEY	P	P
EE_432	AKASH GULABRAO SHASTRI	P	P
EE_433	AKASH MEGHANATH WAGHADE	P	P
EE_437	ANKIT ANIL BHAISARE	P	P
EE_439	ANIKET SHAMRAOJI RAUT	P	P
EE_440	ANIRUDDHA TIKARAMJI KHANDEKAR	P	P
EE_441	ASHISH RAMESH CHANDANE	P	P
EE_472	VAIBHAV SURESH CHAHANDE	P	P
EE_473	VIKESH GANESH SHEDESAR	P	P
EE_474	VINAY RAJKUMAR SAHARE	P	P

Prof. R. V. Lonare
Coordinator

Dr. J. G. Chadhuri
HoD, Electrical



NAGPUR INSTITUTE OF TECHNOLOGY

(Affiliated to RTM Nagpur University & Approved by AICTE New Delhi)

CAMPUS: 13/2, Mahurzari, Near Fetri, Katol Road, Nagpur-441501, India

Email Id: registrar@nit.edu.in Web: www.nit.edu.in Contact No. 09764974144

RTMNU College Code: 315

DTE Code: 4144

AICTE ID : 1-4830701

5.1.2 Following capacity development and skills enhancement activities are organized for improving students' capability in 2020-21

4.Awareness of trends in technology

SN	Name of the capacity development and skills enhancement program	Period (from date - to date)	Number of students enrolled	Name of the agencies/experts involved with contact details
1	3 days Workshop on Solar PV	07-05-2022 to 10-05-2022	17	Mr. Shrikant Ganjare, Co-Founder, Think solar Nagpur
2	3 days National Level Short Term Training Program on "Blockchain Technology & Crypto-currency"	25-06-2021 to 27-06-2021	136	Ms. Khushbu Jain, Cyber Security Experts, Supreme Court, Delhi. Dr. Gouse Baig Mohammed Vardhman College of Engineering, Hyderabad. Prof. Pranav University of Jammu, Kathua. Dr. Vijay B. Gadicha, Dean Academics, G. H. Rasoni University, Amravati. Dr. Mangesh Ghonge, SITRC, Nashik. Dr. Kamal Shah, Dean R&D, TCET, Mumbai. Sandip Bankar, TCET, Mumbai. Er. Raj Arora CEO, Revat Network. Dr. Anil Gupta, Associate Director, CDAC, Pune
3	2 Days Online Workshop on Computer Hardware	17-07-2020 to 18-07-2020	55	Prof. Mohammad Sajid, Assistant Professor, NIT Nagpur
4	2 days workshop on latest Trends in Domain Network Security (DNS)	30-11-2020 to 01-12-2020	15	Prof. Mohammad Sajid, Assistant Professor, NIT Nagpur
5	2 days Online Workshop on Simulation of Power Converter (MATLAB)	19-01-2021 to 20-01-2021	36	Prof. M. Y. Jambulkar and Prof. A. M. Dodke Assistant Professor, Nagpur Institute of Technology, Nagpur



PRINCIPAL
Nagpur Institute of Technology,
Nagpur - 441501.



SHRI SAI SHIKSHAN SANSTHA'S
NAGPUR INSTITUTE OF TECHNOLOGY, NAGPUR
(Approved By AICTE New Delhi & DTE Mumbai(Govt.Of Maharashtra and Affiliated To
Rashtrasant Tukadoji Maharaj NagpurUniversity,Nagpur)
Campus: Survey No.13/2 ,Mahurzari , Near Fetri , Katol Road , Nagpur-441501(INDIA)

Department of Electrical Engineering

Session 2021-22

Notice/Circular

Date: 04/05/2022

All the students of Electrical Engineering are hereby informed that the Department of Electrical Engineering is organizing the 3 days workshop on "Solar PV " on 07-05-2022 to 10-05-2022. The students of third year and final year of Electrical Engineering should attend and actively participate in the event.

Prof. R. V. Lonare
Coordinator

Dr. J. G. Chadhuri
HoD, Electrical

H. O. D.
Department of Electrical Engg.
Nagpur Institute of Technology

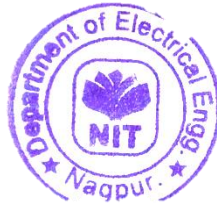

Copy To:

The Principal, NIT, Nagpur
The Dean(Academics), NIT, Nagpur



SHRI SAI SHIKSHAN SANSTHA'S
NAGPUR INSTITUTE OF TECHNOLOGY, NAGPUR
(Approved By AICTE New Delhi & DTE Mumbai(Govt.Of Maharashtra and Affiliated To
Rashtrasant Tukadoji Maharaj NagpurUniversity,Nagpur)
Campus: Survey No.13/2 ,Mahurzari , Near Fetri , Katol Road , Nagpur-441501(INDIA)

Department of Electrical Engineering

Session 2021-22 Activity Report

Date: 03/03/2022

Name of Program – 3 days workshop on “Solar PV Installation ”.

Name of Department- Electrical Engineering

Name of expert - Mr. Shrikant Ganjare, Co-Founder, Think solar Nagpur

Name of activity – Workshop

Venue: Nagpur Institute of Engineering, Nagpur.

Date of event-07-05-2022 to 10-05-2022

Event description

Forum (Feeder) of the Electrical Engineering Department organized a 3 days workshop on “Solar PV Installation ”on 02-03-2022 to 03-03-2022. Expert was MMr. Shrikant Ganjare, Co-Founder, Think solar Nagpur. The Trainer (Co-Founder) Mr. Shrikant Ganjare from Think solar Nagpur had delivered the Session considering future aspects to Research in Solar and its design with applications as today’s era. The overall workshop was coordinated by Prof. R. V. Lonare and team EE.

Inaugural function of workshop with the Hands of Respected HoD Dr. J. G. Chaudhari.



Day-I: All 17 participants gathered at Electrical machine Lab, Expert (Co-founder) Mr. Shrikant Ganjare, guid participant on specification of all components related to solar panel also shows demonstration of different activities about solar panel. The day ends with home work task.

Day-II : Visit to Site

Participants visited the site of installation of the Panel at Yashodhara Skill Lab. Mr. Shrikant Ganjare and his team narrated the students at the beginning and discussed the whole day's plan.

Students got the job of Installing a 10 W Solar panel, with PWM solar charge controller of rating 6 A, 12 V along with battery rating of 7.2 Ah, 12 V and connecting wires.

Students drilled terrace surface for fixing of panel and connected charge controller, battery and load with wiring for OFF grid solar Installation.



SHRI SAI SHIKSHAN SANSTHA'S
NAGPUR INSTITUTE OF TECHNOLOGY, NAGPUR
(Approved By AICTE New Delhi & DTE Mumbai(Govt.Of Maharashtra and Affiliated To
Rashtrasant Tukadoji Maharaj NagpurUniversity,Nagpur)
Campus: Survey No.13/2 ,Mahurzari , Near Fetri , Katol Road , Nagpur-441501(INDIA)

Department of Electrical Engineering

Session 2021-22



Day- II Students Visited Yashodhara Lab and installation work was done by students.

Day-III : Company Visit

On the Last Day, All participants gathered at company premises there and visited a 15kw solar plant having all components, discussed how to select batteries and how to select components. Students were given one task of street lighting working. Students also learn how to make small lamps with minimum price and max year work.



Prof. R. V. Lonare
Coordinator

Dr. J. G. Chadhuri
HoD, Electrical



SHRI SAI SHIKSHAN SANSTHA'S
NAGPUR INSTITUTE OF TECHNOLOGY, NAGPUR
(Approved By AICTE New Delhi & DTE Mumbai(Govt.Of Maharashtra and Affiliated To
Rashtrasant Tukadoji Maharaj Nagpur University, Nagpur)
Campus: Survey No.13/2 ,Mahurzari , Near Fetri , Katol Road , Nagpur-441501(INDIA)

Department of Electrical Engineering

Session 2021-22

Date:-10/05/2022

Activity Attendance Sheet

Topic: - 3 days workshop on "Solar PV Installation"

Expert Name & Designation: Mr. Shrikant Ganjare, Co-Founder, Think solar Nagpur

Year: - Final Year

Roll NO	NAME OF Students	Day 1	DAY 2	Day 3
EE_302	Aishwarya Ghanshyam Alone	P	P	P
EE_303	Aishwarya Jivansingh Gour	P	P	P
EE_312	Dhanshri Dhanraj Khadse	P	P	P
EE_313	Harsha Yograj Mendhe	P	P	P
EE_316	Kalyani Shankarrao Gomase	P	P	P
EE_318	Komal Rameshwar Chaudhari		P	P
EE_320	Neha Gunvanta Kumbhare	P		P
EE_321	Nikita Umesh Sukhadeve	P	P	P
EE_322	Prachi Siddharth Patil	P	P	P
EE_341	Chetan Arvind Getme	P	P	P
EE_345	Kunal Manohar Gawarle	P		P
EE_356	Rutvik Rajendraji Ghonge	P	P	P
EE_358	Sanmay Banduji Ghangale	P	P	P
EE_327	Rutuja Uttam Pikalmunde	P	P	P
EE_363	Sumedh Sahebrao Khillare	P	P	P
EE_365	Tejas Gajanan Raut	P	P	P
EE_359	Saurabh Pramodrao Tayde	P	P	P

Prof. R. V. Lonare

Dr. J. G. Chadhuri



SHRI SAI SHIKSHAN SANSTHA'S
NAGPUR INSTITUTE OF TECHNOLOGY, NAGPUR
(Approved By AICTE New Delhi & DTE Mumbai (Govt. Of Maharashtra and Affiliated To
Rashtrasant Tukadoji Maharaj Nagpur University, Nagpur)
Campus: Survey No.13/2, Mahurzari, Near Fetri, Katol Road, Nagpur-441501 (INDIA)

Department of Electrical Engineering

Session 2021-22

Coordinator

HoD, Electrical



Shri Sai Shikshan Sanstha's
NAGPUR INSTITUTE OF TECHNOLOGY, NAGPUR
Survey No.13/2, Mahurzari, Near Fetri, Katol Road Nagpur-441501
Department of Information Technology
SESSION: 2020-2021



Notice/Circular

Date: 22/06/2021

All the students of Information Technology are hereby informed that the Department of Information Technology is organising, the **Online 3 days Workshop on Current Trend in "Blockchain Technology"** on 25/06/2021 to 27/06/2021 at 11.00 a.m. The students of second year, third year and final year of information technology should attend and actively participate in the event.

Coordinator

M.O.D
Information Technology Dept.
Nagpur Institute of Technology
Nagpur.

Copy To:

- 1) The Principal, NIT, Nagpur
- 2) The Dean(Academics), NIT, Nagpur



Report on Online 3 days Workshop on Current Trend in "Blockchain Technology & Crypto-currency"

Department	: Department of Information Technology
Event Title/Activity Name	: Online 3 days Workshop on Current Trend in "Blockchain Technology"
Date & Time	: 25/06/2021 to 27/06/2021
Venue	: Though Online Media
No of Present Students	: 90
Guest	: Ms. Khushbu Jain, Cyber Security Experts, Supreme Court, Delhi. Dr. Gouse Baig Mohammed Vardhman College of Engineering, Hyderabad. Prof. Pranav University of Jammu, Kath. Dr. Vijay B. Gadicha, Dean Academics, G. H. Rasoni University, Amravati. Dr. Mangesh Ghonge, SITRC, Nashik. Prof. Sandip Bankar, TCET, Mumbai. Dr. Kamal Shah, Dean R&D, TCET, Mumbai. Er. Raj Arora CEO, Revat Network. Dr. Anil Gupta, Associate Director, CDAC, Pune
Program coordinator	: Ms. Shubhangi Chaware, NIT, Nagpur
Objective of program	: To aware the participants about the trends in Blockchain Technology.

THE Department of Information Technology of Nagpur Institute of Technology organized Online 3 days Workshop on Current Trend in "Blockchain Technology" under Internal Quality Assurance Cell(IQAC) of NIT ,recently. The session was conducted by the eminent guests on the various domain of Information Technology. **Ms. Khushbu Jain, Cyber Security Experts, Supreme Court, Delhi.** was the chief guest of the inaugural function. The eminent speakers enlighten the various topic related Blockchain Technology.

Dr. Amol Deshmukh, Principal, NIT, Nagpur gave the introductory remarks. Prof. Jagdish Pimple, Head of Information Technology Department briefed the schedule of training program. Total 1400 Participants registered from various cities like Pune, Delhi , Mumbai and Nagpur etc for the event. During the one week session the participants were briefed about public digital ledger of transactions that records information in a way that makes it difficult to hack or alter. The technology allows a secure way for individuals to deal directly with each other, without an intermediary like a government, bank or other third party.

On the valedictory ceremony **Dr. Anil Gupta, Associate Director, CDAC, Pune,** Addressed the connected participants. Dr. Amol Deshmukh Principal , NIT Appreciated the event that the session was very helpful for the students as well as faculty members to polish their personal skill in professional life.

Coordinator

H.O.D.
Information Technology Dept.
Nagpur Institute of Technology
Nagpur.



Glimpses of The Event :

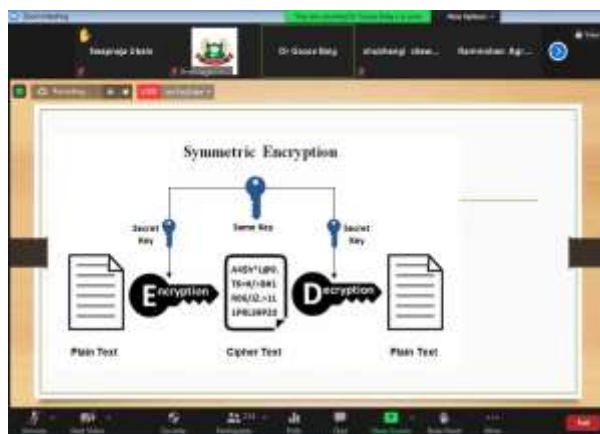



Shri Sai Shikshan Sanstha's
NAGPUR INSTITUTE OF TECHNOLOGY, NAGPUR
Survey No.13/2, Mahurzari, Near Fetri, Katol Road Nagpur-441501
Department of Information Technology
SESSION: 2020-2021

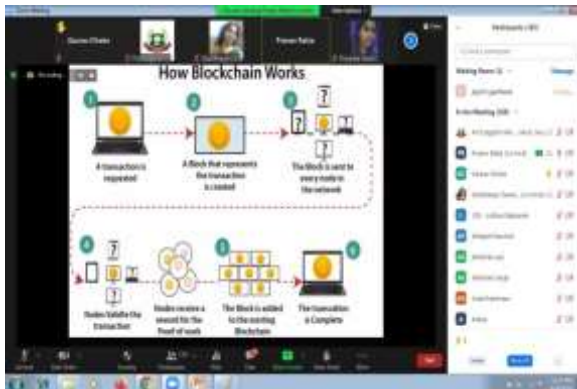

Asit Chaware
Coordinator

Simple
M.O.D.
Information Technology Dept.
Nagpur Institute of Technology
Nagpur.



Shri Sai Shikshan Sanstha's
NAGPUR INSTITUTE OF TECHNOLOGY, NAGPUR
Survey No.13/2, Mahurzari, Near Fetri, Katol Road Nagpur-441501
Department of Information Technology
SESSION: 2020-2021



List Of Present Students From 3rd Year

Name Of Student	Status	Name Of Student	Status
Rashmi Deepak Boradkar	P	Niran Deolalji Hande	P
Aadishsingh Prakashsingh Chouhan	P	Pallavi Rajesh Suryavanshi	P
Achal Janrao Irpati	P	Poornima Vikas Ingle	
Aditi Omprakash Godar		Prachi Puransingh Lohi	P
Akanksha Naresh Dudhkaware	P	Prajakta Shripal Gadpayale	P
Akash Bhagwan Meshram	P	Pratiksha Nirvikar Adhau	P
Akash Haresh Bodele	P	Pravin Khushal Kakde	
Akshay Sudhakar Pawar	P	Prerana Subhashrao Dahiwade	P
Anjali Suresh Kaithwas		Pritee Kamleshwar Banewar	P
Ankita Sanjayrao Dhunde	P	Priya Dinesh Shukla	
Arati Rajesh Bagde	P	Priyanka Niranjan Dhongde	P
Ashwini Ganpat Gaikwad	P	Ritesh Chandrashekhar Basotiya	P
Atharva Shyam Deshmukh	P	Rohini Hemraj Bhondekar	
Bhaves Shrawan Mule		Roshani Damodhar Kolhe	P
Chand Suraj Usarbarse	P	Rushanshi Raghunath Amnerkar	P
Dhanashri Tejram Ghugal	P	Sachin Raju Deshpande	
Dhanshri Manohar Kale	P	Sahil Nilkanth Kadu	P
Disha Onkar Diyewar	P	Sakshi Ramesh Rao Lambat	P
Ekta Ashok Rahangdale	P	Saurabh Madhukar Malwar	P
Gayatri Radhelal Sahu	P	Sayali Sunil Gujar	
Hariom Radheshyam Acharya	P	Sejal Arun Hadge	P
Himanshu Krishnkumar Dixit	P	Shaksham Sanjeevkumar Sahu	P
Ishan Gunwant Kshirsagar	P	Shantanu Jivan Waikar	
Jyoti Rameshwar Thakre		Shipali Vinod Narnaware	P
Kalyani Raju Kanoje	P	Shubham Suresh Kothe	P
Kanchan Kothiramji Zode		Shweta Sunil Gavhande	P
Komal Vasant Utane	P	Sneha Suresh Wadhai	P
Kushika Shrinu Naidu	P	Snehal Vijayraoji Wanjari	
Malyika Umesh Dahiwale		Somesh Ramesh Meshram	P
Manasi Manohar Bagde	P	Swati Sanjay Raut	
Manisha Mahesh Talewar	P	Vaibhav Ashok Dharnidhar	P
Manjusha Prabhakar Ramteke	P	Vrushali Shrawan Thombare	P



Shri Sai Shikshan Sanstha's
NAGPUR INSTITUTE OF TECHNOLOGY, NAGPUR
Survey No.13/2, Mahurzari, Near Fetri, Katol Road Nagpur-441501
Department of Information Technology
SESSION: 2020-2021



List Of Present Students From 4th Year

Name Of Student	Status	Name Of Student	Status
Akash Yuvraj Patil	P	Pallavi Ramesh Khorgade	P
Akshay Diwakar Wankar	P	Paritosh Nagorao Bangadkar	P
Amruta Rampravesh Yadav	P	Pooja Bhagwat Meshram	P
Anjali Ashok Nandagawali		Pranay Dhanraj Marbate	
Ashish Shubhash Dahagnae	P	Pranjal Vilasrao Makeswar	P
Ayushi Ravindra Nitnaware	P	Priyanka Rajendra Kamble	P
Chitra Dipak Lakhapati		Puja Yashwant Nikhare	
Damini Santosh Jambhulkar	P	Rasika Gangadhar Patil	P
Diksha Keshav Umare	P	Rohan Praful Wahane	P
Ganesh Youvraj Borkar	P	Ruby Devendra Khobragade	P
Harshal Devandra Bende		Rupali Dilip Borkar	P
Jeevan Sudhakar Suryawanshi	P	Sachin Krushnrao Bhorkar	
Jivika Dipakrao Gotmare	P	Shashank Rajkumar Bhimte	P
Kalyani Pralhad Gholse	P	Shashank Suresh Shivrekar	P
Kirti Abhiman Adikane	P	Shravan Puroshottam Kela	P
Konika Suresh Katkar		Shreya Pundlik Hedaoo	P
Madhuri Ramesh Badwaik	P	Shruti Nakul Barmate	P
Mahesh Dnyaneshwar Warghane	P	Shubhangi Anand Wasnik	P
Mansi Rajhans Sangole	P	Sneha Dhanraj Farkhade	
Mayur Vinod Meshram	P	Sneha Praksh Gawande	P
Md. Asrar Qamar Ansari	P	Snehal Deoram Parate	
Monalika Devendraji Kakde	P	Trupti Harish Nandanwar	P
Nayan Sharad Patel	P	Trupti Narayan Dahake	P
Neha Ganpati Barapatre		Vaishnavi Devendraji Nerkar	P
Nitin Naresh Garg	P	Yogesh G Chauriwar	P

Coordinator

M.O.D.
Information Technology Dept.
Nagpur Institute of Technology
Nagpur.



Department of Computer Science Engineering

Session: 2020-21

Date:15/07/2020

Notice

All the students are hereby informed that the, CSE Department is organizing **Webinar On "Computer Hardware"** is schedule on **Date of event-17-7-2020**. All the students must be present at the mentioned venue & time below.

Venue: Online Zoom Platform

Prof. Mohammad Sajid
Event Coordinator

Prof. A. Gabankari
Head, CSE Deptt.
H.O.D.
Computer Science & Engineering Dept.
Nagpur Institute of Technology
Nagpur.

Copy To :

1. Circulation in Class of VIII Semester
2. Notice Board
3. Office File



Department of Computer Science Engineering

Session: 2020-21

Date: 19/7/2020

Activity Report On "Online Workshop on Computer Hardware"

Name of Program - "Online Workshop on' Computer Hardware"

Name of Department- Computer Science & Engineering

Name of organization- Nagpur Institute of Technology, Nagpur

Name of activity – Online Workshop on' Computer Hardware'

Venue: Online Zoom Platform

Date of event- 17-7-2020

Department of Computer Science & Engineering organized an Online Workshop on' **Computer Hardware' conducted by Prof.Mohammad Sajid** for Final Year, Third Year, and Second Year Students of Computer Science and Engineering Department, using ZOOM on dated 17 July 2020 nearly 50 plus students attended the workshop.

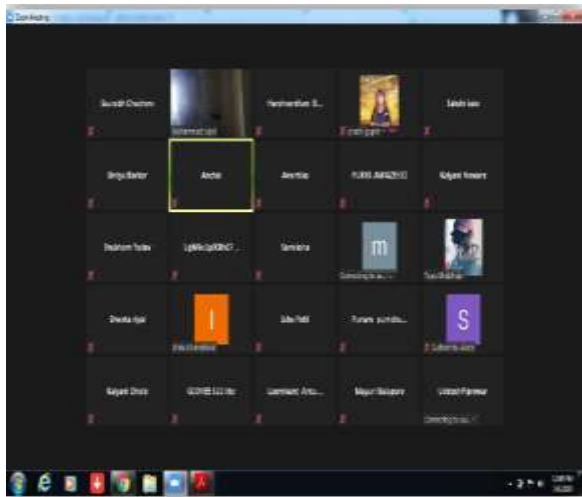

Prof. Mohammad Sajid
Event Coordinator

Prof. A. Gahankari
Head, CSE Deptt.
H.O.D.
Computer Science & Engineering Dept.
Nagpur Institute of Technology
Nagpur.



Department of Computer Science Engineering

Session: 2020-21

List Of Present Students from 4rd year			
NAME OF STUDENTS		NAME OF STUDENTS	
Abhijeet Dattaraj Shrikhande		Nikita Arun Samarth	
Abhishek Prasad Pandey		Prachi Baliram Thote	P
Achal Yashwant Meshram	P	Pranali Yashwantrao Tirpude	
Amit Naresh Bagde		Prateek Vijay Bheevgade	
Amit Shatrughan Meshram		Pratiksha Ramuji Harle	P
Anjali Manoj Pathak		Prerna Mangal Wasnik	
Anjali Sanjay Kharapkar	P	Ravi Ranjan Singh	P
Ankita Madan Chawariya		Rohit Vijay Batho	
Ankush Nilknath Dhakate	P	Ruchira Parasram Shrikhande	
Apurva Naresh Thaokar	P	Sarika Rakesh Chaturvedi	
Arati Rupraoji Somkuwar		Saurabh Sunilrao Dhok	
Arnold Ernest Dsilva	P	Sejal Sanjay Chinchulkar	
Bhagyashri Chhaganlal Borikar		Shruti Rajesh Kamble	
Bhavika Prabhakar Ghormade		Shubham Narayan Duby	
Chetna C Likhar	P	Shubhangi Govindrao Wankhede	P
Diksha Devidas Bagde		Shweta Dilip Shende	P
Dipalee Raju Surwanshi		Tarun Arun Narekar	
Dipti Jayadeoji Ukunde	P	Vikas Babalu Arodiya	P
Dishant Vilas Bawankule		Anjali Vasantrya Durugkar	
Divya Kailash Bambodkar		Neha Bhaurao Bhalerao	P
Falguni Balardas Khobragade		Reshma Ramhari Fate	
Falguni Sudhakar Deshpande	P	Roshani Prabhakar Gajbhiye	P
Gajanan Annaji Godbole		Ashwajit Dipchand Kamble	
Garima Ghanshyam Rai	P		
Kajal Gautam Dabrase			
Kajal Narayan Neware			
Kajal Ranjan Mate	P		
Kalyani Prakash Wankhede	P		
Kavita Raju Jagtap			



Department of Computer Science Engineering

Session: 2020-21

Kunal Yogesh Shendre	P		
Kundanraj Jairaj Singh	P		
Kurvesh G. Sathawane			
Maresh Mahesh Singade	P		
Nandini Rajkumar Pillewar			
Nawaz Munawer Gazi			
Neha Bandu Patil	P		

List Of Present Students From 3rd Year

NAME OF STUDENTS		NAME OF STUDENTS	
Aboli Siddharth Patil		Prajakta Haridas Umale	P
Aditya Jitendra Gupta		Prajwala Sanjay Adkane	
Aishwarya Bandu Khobragade		Pranali Vasanta Warkhede	
Akash Arun Kalambe	P	Pranit Nandalal Sakharwade	P
Akash Vinayakrao Shinde		Pratiksha Yashwant Meshram	
Akshay Anand Meshram	P	Pravin Sitaram Madavi	P
Akshay Ashok Golange	P	Priya Sanjay Raghtate	
Aman Ishwar Parate	P	Purva Nathulal Bisne	
Amit Rupchand Shende		Rajat Sanjay Gaiki	P
Anisha Ashwin Gedam	P	Rani Shamrao Wanjari	
Anjali Chandrashekhar Sawarkar		Ritik Raju Mohite	
Ankit_Govind_Singh		Rohini Balaji Dhakate	
Arhat Hiralal Notey	P	Rupali Mahendra Indurkar	
Ashish Vasanttrao Bhagat		Rupali Raju More	
Ashwin Divakar Kalbande		Rushikesh Manish Mule	
Bharti Hemraj Shende	P	Rutuja Narayan Wanjari	
Chanchal Hirakumar Sahani	P	Samiksha Sudam Khandait	
Darshana Devanand Chokhandre		Sayali Sunil Thakare	P
Deepa Chandragopal Gupta		Shubham Rajendra Wasekar	
Devyani Manoj Parate	P	Shubham Ramesh Shinde	P



Department of Computer Science Engineering

Session: 2020-21

Divyani Chandrashekhar Shende		Shubhangi Mahadeorao Bagwe	
Dnyanesh Bhimrao Tagde	P	Sonal Anil Kawalkar	P
Harshada Durdev Pawar		Sonali Pradip Mohod	P
Heareen Harshwardhan Raut		Spruha Kashyap Shamkuwar	
Kajal Hawsilal Pardhi	P	Sumesh Narendra Patil	P
Kajal Vilas Kawale		Swapnil Narendra Jadhav	
Kanchan Prasanna Chavan		Tejas Kishor Patil	P
Komal Kalu Kelvade	P	Tejsvi Sunil Moon	
Lina Gajanan Godbole	P	Tinal Subhash Ganeshkar	P
Mayur Suresh Meshram		Upasana Chandramani Dhongle	
Megha Ramesh Gaikwad	P	Vaishnavi Nandlal Khandate	P
Monika Vishnu Dhole		Vaishnavi Sunil Wasankar	
Muskan Kailash Banafarraai	P	Yash Santosh Gadling	
Muskan Vinod Khandekar		Yash Vishnu Jakhotiya	
Neha Roshan Dongre	P	Yashika Sharad Nimje	
Nitiksha Suresh Nitnaware			
Palak Jaydeep Garhwal	P		
Payal Harichand Zodape	P		
Piyush Onkar Kadikhaye			
Prachi Pandurang Tijare			

Prof. Mohammad Sajid
Event Coordinator

Prof. A. Gabankari
Head, CSE Deptt.
H.O.D.
Computer Science & Engineering Dept.
Nagpur Institute of Technology
Nagpur.



Department of Computer Science Engineering

Session: 2020-21

Date:28/11/2020

Notice

All the students are hereby informed that the, CSE Department is organizing **Webinar On "2 Days workshop on DNS"** is schedule on **Date of event- 30-11-2020**. All the students must be present at the mentioned venue & time below.

Venue: Online Zoom Platform

Prof. Mohammad Sajid
Event Coordinator

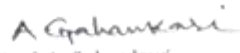
Prof. A. Gahankari
Head, CSE Deptt.
H.O.D.
Computer Science & Engineering Dept.
Nagpur Institute of Technology
Nagpur.

Copy To :

1. Circulation in Class of All Semester
2. Notice Board
3. Office File



Department of Computer Science Engineering
 Session: 2020-21

Date -30-11-2020

Activity Report On “2 Days workshop on DNS”

Name of Program - workshop
Name of Department- Computer Science & Engineering
Name of organization- Nagpur Institute of Technology, Nagpur
Name of activity – 2 Days workshop on DNS
Venue: Online Zoom Platform
Date of event-30-11-2020

Department of Computer Science & Engineering organized a workshop on DNS (Domain Name Service), For the students of all Computer Science and Engineering Department, 3rd, 5th and 7th Sem Students on dated 30 November 2020.

DAY1: Basics of Forest and Tree

DAY2: DNS Structure



 Prof. Mohammad Sajid
 Event Coordinator

 Prof. A. Gahankari
 Head, CSE Deptt.
 H.O.D.
 Computer Science & Engineering Dept.
 Nagpur Institute of Technology
 Nagpur.



Department of Computer Science Engineering

Session: 2020-21

List Of Present Students from 4th year			
NAME OF STUDENTS		NAME OF STUDENTS	
Abhijeet Dattaraj Shrikhande		Nikita Arun Samarth	P
Abhishek Prasad Pandey	P	Prachi Baliram Thote	P
Achal Yashwant Meshram	P	Pranali Yashwantrao Tirpude	P
Amit Naresh Bagde		Prateek Vijay Bheevgade	
Amit Shatrughan Meshram	P	Pratiksha Ramuji Harle	P
Anjali Manoj Pathak	P	Prerna Mangal Wasnik	P
Anjali Sanjay Kharapkar	P	Ravi Ranjan Singh	P
Ankita Madan Chawariya		Rohit Vijay Batho	
Ankush Nilknath Dhakate	P	Ruchira Parasram Shrikhande	P
Apurva Naresh Thaokar	P	Sarika Rakesh Chaturvedi	P
Arati Rupraoji Somkuwar		Saurabh Sunilrao Dhok	
Arnold Ernest Dsilva	P	Sejal Sanjay Chinchulkar	P
Bhagyashri Chhaganlal Borikar		Shruti Rajesh Kamble	
Bhavika Prabhakar Ghormade		Shubham Narayan Duby	
Chetna C Likhar	P	Shubhangi Govindrao Wankhede	P
Diksha Devidas Bagde	P	Shweta Dilip Shende	P
Dipalee Raju Surwanshi		Tarun Arun Narekar	
Dipti Jayadeoji Ukunde	P	Vikas Babalu Arodiya	P
Dishant Vilas Bawankule		Anjali Vasantrya Durugkar	
Divya Kailash Bambodkar	P	Neha Bhaurao Bhalerao	P
Falguni Balardas Khobragade		Reshma Ramhari Fate	
Falguni Sudhakar Deshpande	P	Roshani Prabhakar Gajbhiye	P
Gajanan Annaji Godbole	P	Ashwajit Dipchand Kamble	
Garima Ghanshyam Rai	P		
Kajal Gautam Dabrase			
Kajal Narayan Neware	P		
Kajal Ranjan Mate	P		
Kalyani Prakash Wankhede	P		
Kavita Raju Jagtap			



Department of Computer Science Engineering

Session: 2020-21

Kunal Yogesh Shendre	P		
Kundanraj Jairaj Singh	P		
Kurvesh G. Sathawane			
Maresh Mahesh Singade	P		
Nandini Rajkumar Pillewar			
Nawaz Munawer Gazi			
Neha Bandu Patil	P		

List Of Present Students From 3rd Year

NAME OF STUDENTS		NAME OF STUDENTS	
Aboli Siddharth Patil	P	Prajakta Haridas Umale	P
Aditya Jitendra Gupta	P	Prajwala Sanjay Adkane	P
Aishwarya Bandu Khobragade	P	Pranali Vasanta Warkhede	
Akash Arun Kalambe	P	Pranit Nandalal Sakharwade	P
Akash Vinayakrao Shinde		Pratiksha Yashwant Meshram	
Akshay Anand Meshram	P	Pravin Sitaram Madavi	P
Akshay Ashok Golange	P	Priya Sanjay Raghtate	
Aman Ishwar Parate	P	Purva Nathulal Bisne	
Amit Rupchand Shende		Rajat Sanjay Gaiki	P
Anisha Ashwin Gedam	P	Rani Shamrao Wanjari	
Anjali Chandrashekhar Sawarkar	P	Ritik Raju Mohite	P
Ankit_Govind_Singh		Rohini Balaji Dhakate	
Arhat Hiralal Notey	P	Rupali Mahendra Indurkar	
Ashish Vasanttrao Bhagat		Rupali Raju More	
Ashwin Divakar Kalbande		Rushikesh Manish Mule	
Bharti Hemraj Shende	P	Rutuja Narayan Wanjari	
Chanchal Hiralakumar Sahani	P	Samiksha Sudam Khandait	
Darshana Devanand Chokhandre		Sayali Sunil Thakare	P
Deepa Chandragopal Gupta		Shubham Rajendra Wasekar	
Devyani Manoj Parate	P	Shubham Ramesh Shinde	P



Department of Computer Science Engineering

Session: 2020-21

Divyani Chandrashekhar Shende		Shubhangi Mahadeorao Bagwe	
Dnyanesh Bhimrao Tagde	P	Sonal Anil Kawalkar	P
Harshada Durdev Pawar		Sonali Pradip Mohod	P
Heareen Harshwardhan Raut		Spruha Kashyap Shamkuwar	
Kajal Hawsilal Pardhi	P	Sumesh Narendra Patil	P
Kajal Vilas Kawale	P	Swapnil Narendra Jadhav	
Kanchan Prasanna Chavan	P	Tejas Kishor Patil	P
Komal Kalu Kelvade		Tejsvi Sunil Moon	
Lina Gajanan Godbole		Tinal Subhash Ganeshkar	P
Mayur Suresh Meshram	P	Upasana Chandramani Dhongle	
Megha Ramesh Gaikwad		Vaishnavi Nandlal Khandate	P
Monika Vishnu Dhole		Vaishnavi Sunil Wasankar	
Muskan Kailash Banafarraai		Yash Santosh Gadling	
Muskan Vinod Khandekar		Yash Vishnu Jakhotiya	
Neha Roshan Dongre		Yashika Sharad Nimje	
Nitiksha Suresh Nitnaware	P		
Palak Jaydeep Garhwal			
Payal Harichand Zodape			
Piyush Onkar Kadikhaye			
Prachi Pandurang Tijare			

Prof. Mohammad Sajid
Event Coordinator

Prof. A. Gahankari
Head, CSE Deptt.
H.O.D.
Computer Science & Engineering Dept.
Nagpur Institute of Technology
Nagpur.



SHRI SAI SHIKSHAN SANSTHA'S
NAGPUR INSTITUTE OF TECHNOLOGY, NAGPUR
(Approved By AICTE New Delhi & DTE Mumbai(Govt.Of Maharashtra and Affiliated To
Rashtrasant Tukadoji Maharaj NagpurUniversity,Nagpur)
Campus: Survey No.13/2 ,Mahurzari , Near Fetri , Katol Road , Nagpur-441501(INDIA)

Department of Electrical Engineering

Session 2020-21 Notice/Circular

Date:25/02/2020

All the students of Electrical Engineering are hereby informed that the Department of Electrical Engineering is organizing the "2 days Online Workshop on Simulation of Power Converter using MATLAB" on 19-01-2021 to 20-01-2021. The students of Electrical Engineering should attend and actively participate in the event.

Prof. R. V. Lonare
Coordinator

Dr. J. G. Chadhuri
HoD, Electrical

H. O. D.
Department of Electrical Engg.
Nagpur Institute of Technology



Copy To:

The Principal,NIT, Nagpur
The Dean(Academics),NIT,Nagpur



SHRI SAI SHIKSHAN SANSTHA'S
NAGPUR INSTITUTE OF TECHNOLOGY, NAGPUR
(Approved By AICTE New Delhi & DTE Mumbai(Govt.Of Maharashtra and Affiliated To
Rashtrasant Tukadoji Maharaj NagpurUniversity,Nagpur)
Campus: Survey No.13/2 ,Mahurzari , Near Fetri , Katol Road , Nagpur-441501(INDIA)

Department of Electrical Engineering

Session 2020-21 Activity Report

Date: 29/02/2020

- Topic** : Simulation of Power Converter using MATLAB
- Expert** : Prof. M. Y. Jambulkar and Prof. A. M. Dodke Assistant Professor, Nagpur Institute of Technology, Nagpur
- Date** : 19-01-2021 to 20-01-2021
- Details of Participants:** HOD, all teaching faculties of Electrical Engineering Department and Third (5thSem) and Final Year (7thSem) Students
- Aim** :To deliver key aspects in Power Converter using MATLAB.
- Objectives** : To understand Simulation of Power Converter using MATLAB

Introduction:

Department of Electrical Engineering , Nagpur Institute of Technology, Nagpur organized a Workshop as part of curriculum based on “Simulation of Power Converter using MATLAB” for the 3rd and Final Year (BE) Electrical Engineering Students on 19-01-2021 to 20-01-2021 . Expert was Prof. M. Y. Jambulkar and Prof. A. M. Dodke Assistant Professor, Nagpur Institute of Technology, Nagpur . The Faculties delivered the Session considering future aspects to Simulation of Power Converter using MATLAB with applications as in today's era.

Outcome of Seminar:

Students get to know theoretical and Practical part of simulation of Power Converter using MATLAB

Conclusion:

Students get knowledge about simulation of Power Converter using MATLAB Theoretically and Practically.

Acknowledgment:

On behalf of the Electrical Engineering Department we sincerely thank Prof. M. Y. Jambulkar and Prof. A. M. Dodke Assistant Professor, Nagpur Institute of Technology, Nagpur for Taking Workshop on “Simulation of Power Converter using MATLABSimulation of Power Converter using MATLAB”to our students.



**SHRI SAI SHIKSHAN SANSTHA'S
NAGPUR INSTITUTE OF TECHNOLOGY, NAGPUR**
(Approved By AICTE New Delhi & DTE Mumbai(Govt.Of Maharashtra and Affiliated To
Rashtrasant Tukadoji Maharaj NagpurUniversity,Nagpur)
Campus: Survey No.13/2 ,Mahurzari , Near Fetri , Katol Road , Nagpur-441501(INDIA)

Department of Electrical Engineering

Session 2020-21

Our deep sense of gratitude to Dr. Amol Deshmukh, Principal, N.I.T. for providing support in organizing the Seminar.

Event Photos:

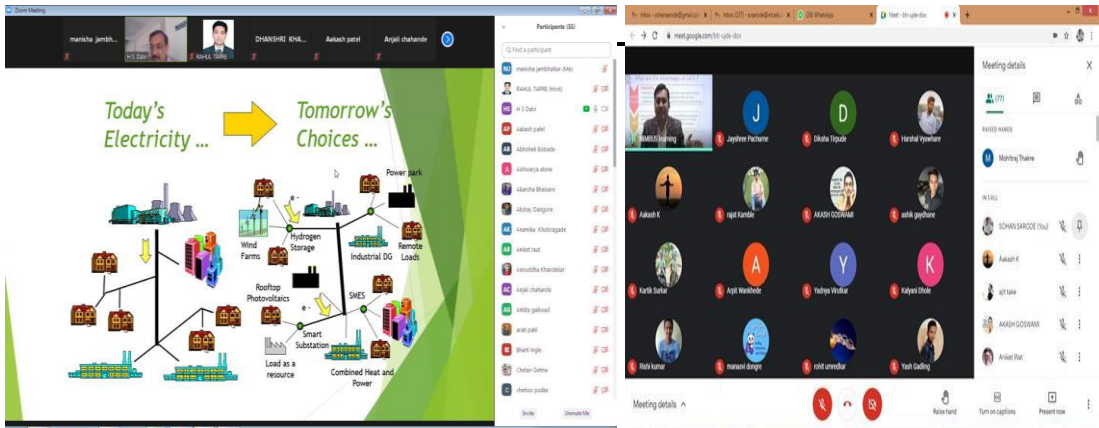

R.V.

Prof. R. V. Lonare
Coordinator

J.G.

Dr. J. G. Chadhuri

HoD, Electrical

H. O. D.

**Department of Electrical Engg.
Nagpur Institute of Technology**

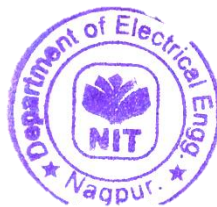



SHRI SAI SHIKSHAN SANSTHA'S
NAGPUR INSTITUTE OF TECHNOLOGY, NAGPUR
(Approved By AICTE New Delhi & DTE Mumbai(Govt.Of Maharashtra and Affiliated To
Rashtrasant Tukadoji Maharaj Nagpur University, Nagpur)
Campus: Survey No.13/2 ,Mahurzari , Near Fetri , Katol Road , Nagpur-441501(INDIA)

Department of Electrical Engineering

Session 2020-21

Date:-29/02/2020.

Activity Attendance Sheet

Topic: - Simulation of Power Converter using MATLAB

Expert Name & Designation: Prof. M. Y. Jambulkar and Prof. A. M. Dodke Assistant Professor,
Nagpur Institute of Technology, Nagpur

Year: - Third Year

Roll No.	Name of Student	Att. DAY 1	Att Day 2
301	Aakash Zallar Patel	P	P
302	Aakash Waghade	P	P
303	Ajay Ishwarji Yuwanate	P	P
304	Akash Gulabrao Shastri	P	P
305	Akash Subhash Ingole	P	P
306	Akshay Ramrao Dangore	P	P
307	Aniket Balwantrao Bhalavi	P	P
308	Aniket Shamraoji Raut	P	P
309	Aniruddha Tikaramji Khandekar	P	P
310	Anjali Yashwant Chahande	P	P
311	Ankit Anil Bhaisare	P	P
312	Ankita Wasudeo Parate	P	P
313	Ashish Ramesh Chandane	P	P
314	Ashish Vasanta Sorte	P	P
315	Ashwini Sudhakar Gaurkhede	P	P
316	Bharti Vijay Ingle	P	P
317	Devashish Prakash Awachat	P	P
318	Dhiraj Chandrashekhar Tagde		P
319	Diksha Bapurao Patil	P	P
320	Dilkhush Shivahri Ramteke		P
321	Eliza Javed Sheikh Sheikh	P	P
322	Gayatri Harichandra Chopade		P
323	Isha Deepak Meshram	P	P
324	Ishita Manoj Jumde		P
325	Khushboo Ganesh Ladhe	P	P
326	Khushboo Shivaji Bagde	P	P
327	Kunal Ratnakar Bhagat		P
328	Lalit Shukracharya Dhurve	P	P
329	Lucky Suresh Sarode		P



SHRI SAI SHIKSHAN SANSTHA'S
NAGPUR INSTITUTE OF TECHNOLOGY, NAGPUR
(Approved By AICTE New Delhi & DTE Mumbai(Govt.Of Maharashtra and Affiliated To
Rashtrasant Tukadoji Maharaj NagpurUniversity,Nagpur)
Campus: Survey No.13/2 ,Mahurzari , Near Fetri , Katol Road , Nagpur-441501(INDIA)

Department of Electrical Engineering

Session 2020-21

330	Manish Chandrashekhar Raut	P	P
331	Manisha Devalal Choukikar		P
332	Mayuri Chandrabhan Pal	P	P
333	Mithesh Vilas Kalaskar		P
334	Nikhil Khatu Dupare	P	P
335	Nikhil Uttamrao Nagrale		P
336	Nikita Chirkut Nitnaware		P
337	Pooja Anil Dhole	P	P
338	Prachi Ganesh Sonsare		P
339	Prachi Madhukar Meshram	P	P
340	Prajwal Ashok Khante	P	P
341	Pranay Gangadhar Kale	P	P
342	Rajnandan Balwant Dhawale	P	P
343	Rakhi Maroti Bagde		P
344	Rakhi Ramaji Kurmate		P
345	Sachin Ratnakar Raut	P	P
346	Sagar Dhanraj Hedau		P
347	Samiksha Chudaman Ukey		P
348	Samiksha Nandkishor Tiwaskar	P	P
349	Saurabh Prabhakar Gaikwad		P
350	Shivani Anil Choudhary	P	P
351	Sneha Pundlik Pande		P
352	Sonali Chandrabhan Raut		P
353	Sonu Prakash Borkar	P	P
354	Swapnil Sadanand Gharde		P
355	Tejas Madhavrao Wankhade		P
356	Vaibhav Anantrao Dhole	P	P
357	Vaibhav Bharatrao Naik		P
358	Vikesh Ganesh Shedesar		P
359	Vinay Rajkumar Sahare	P	P
360	Akash Bhaiyyaji Goswami		P
361	Diksha Laxman Gautre	P	P
362	Ravina Ashok Uikey		P
363	Riddhi Nandakishor Gurbhele	P	P
364	Sakshay Chhatrapal Anjankar		P
365	Shriya Budhraj Faye		P



SHRI SAI SHIKSHAN SANSTHA'S
NAGPUR INSTITUTE OF TECHNOLOGY, NAGPUR
(Approved By AICTE New Delhi & DTE Mumbai(Govt.Of Maharashtra and Affiliated To
Rashtrasant Tukadoji Maharaj NagpurUniversity,Nagpur)
Campus: Survey No.13/2 ,Mahurzari , Near Fetri , Katol Road , Nagpur-441501(INDIA)

Department of Electrical Engineering

Session 2020-21

366	Vaibhav Suresh Chahande	P	P
367	Ujwal Ingle		P
368	Shubham Raju Rangari		P
369	Sonwane	P	P
370	Rohit Naresh Dongre		P
371	Akashay Dilip Meshram	P	P
372	Sagar Yonath Shahare	P	P

Prof. R. V. Lonare
Coordinator

Dr. J. G. Chadhuri
HoD, Electrical



NAGPUR INSTITUTE OF TECHNOLOGY

(Affiliated to RTM Nagpur University & Approved by AICTE New Delhi)

CAMPUS: 13/2, Mahurzari, Near Fetri, Katol Road, Nagpur-441501, India

Email Id: registrar@nit.edu.in Web: www.nit.edu.in Contact No. 09764974144

RTMNU College Code: 315

DTE Code: 4144

AICTE ID : 1-4830701

5.1.2 Following capacity development and skills enhancement activities are organized for improving students' capability in 2019-20

4.Awareness of trends in technology

SN	Name of the capacity development and skills enhancement program	Period (from date - to date)	Number of students enrolled	Name of the agencies/experts involved with contact details
1	Online Workshop on IOT	20-06-2020 to 20-06-2020	60	Mr. jayesh Gautam, InTronix Pvt Ltd, Nagpur
2	Online Workshop on C Sharp using Dot Net	15-06-2020 to 18-06-2020	65	Mr.Nilesh Gupta,CEO,NRSolutions4u.com
3	3 days online workshop on WORD PRESS	15-05-2020 to 17-05-2020	37	Mr. Mohit Kewate, Digital Soft tech, Nagpur
4	3 days online workshop on Android	01-05-2020 to 03-05-2020	37	Mr. Mohit Kewate, Digital Soft tech, Nagpur
5	2 Days workshop on Design Software's in Civil Engineering	09-09-2019 to 10-09-2019	60	Mr. Nitin & Ms Anjali, Astral Institute Pvt Ltd, Nagpur
6	2 Days Online Workshop on PV Solar	28-02-2020 to 29-02-2020	30	Mr. Shrikant Ganjare, Co-Founder, Think solar Nagpur
7	2 days workshop on `Drawing Software for Electrical Engineers	27-02-2020 to 28-02-2020	32	Er. Akash Thakre, Elect Design Engr Astral Informatic Pvt Ltd
8	2 days Online Workshop on Simulation of Power Conveter using MATLAB	19-09-2019 to 20-09-2019	26	Dr. M M Renge, Prof EE, RCOEM



PRINCIPAL
Nagpur Institute of Technology,
Nagpur - 441501.



Department of Computer Science Engineering

Session: 2019-20

Date:18/06/2020

Notice

All the students are hereby informed that the, CSE Department is organizing **Webinar** **"Workshop on IOT"** is schedule on **Date of event-20-6-2020** . All the students must be present at the mentioned venue & time below.

Venue: Online Zoom Platform

Prof. Mahvash Khan
Event Co-ordinator

Prof. A. Gahankari
Head, CSE Deptt.

H.O.D.
Computer Science & Engineering Dept.
Nagpur Institute of Technology
Nagpur.

Copy To :

1. Circulation in Class of VIII Semester
2. Notice Board
3. Office file



Department of Computer Science Engineering
Session: 2019-20

Date -20-6-2020

Report On "Workshop on IOT"

Name of Program - Workshop on IOT

Name of Department- Computer Science & Engineering

Name of organization- Nagpur Institute of Technology, Nagpur

Name of activity – Workshop on IOT

Venue: Online Zoom Platform

Date of event-20-6-2020

Department of Computer Science & Engineering organized an **Online Workshop on IOT for Polytechnic Students by Mr. Jayesh Gautam ,IoTronix,pvt ltd Nagpur**. He has elaborated all the trends that are available in IoT and discussed how students can make project on this. Polytechnic Students attended the webinar.

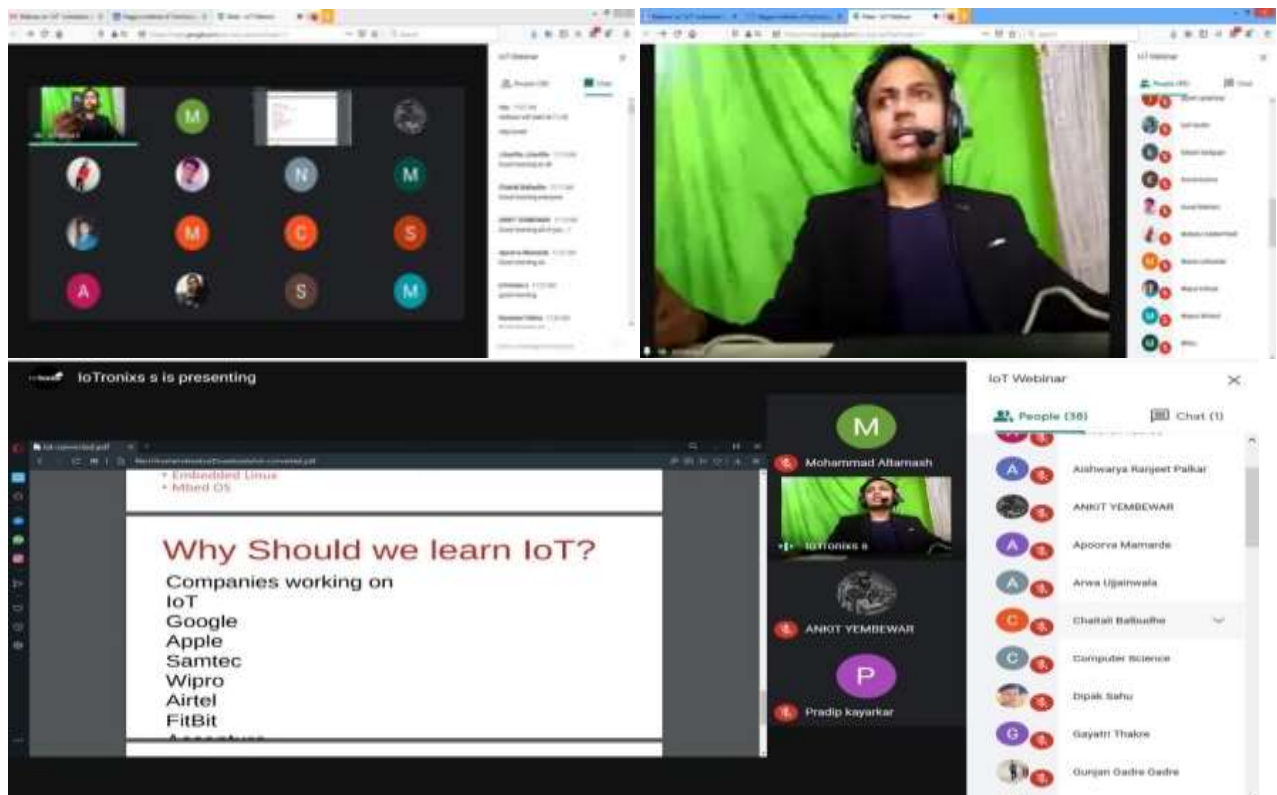

M. Khan
Prof. Mahvash Khan
Event Co-ordinator

A. Gahankari
Prof. A. Gahankari
Head, CSE Deptt.
H.O.D.
Computer Science & Engineering Dept.
Nagpur Institute of Technology
Nagpur.



Department of Computer Science Engineering

Session: 2019-20

List Of Present Students from 3rd year

NAME OF STUDENTS		NAME OF STUDENTS	
Abhijeet Dattaraj Shrikhande	P	Nikita Arun Samarth	
Abhishek Prasad Pandey	P	Prachi Baliram Thote	
Achal Yashwant Meshram		Pranali Yashwantrao Tirpude	P
Amit Naresh Bagde	P	Prateek Vijay Bheevgade	P
Amit Shatrughan Meshram	P	Pratiksha Ramuji Harle	P
Anjali Manoj Pathak	P	Prerna Mangal Wasnik	
Anjali Sanjay Kharapkar		Ravi Ranjan Singh	P
Ankita Madan Chawariya		Rohit Vijay Batho	
Ankush Nilknath Dhakate		Ruchira Parasram Shrikhande	P
Apurva Naresh Thaokar	P	Sarika Rakesh Chaturvedi	P
Arati Rupraoji Somkuwar	P	Saurabh Sunilrao Dhok	
Arnold Ernest Dsilva		Sejal Sanjay Chinchulkar	P
Bhagyashri Chhaganlal Borikar		Shruti Rajesh Kamble	
Bhavika Prabhakar Ghormade	P	Shubham Narayan Duby	
Chetna C Likhar		Shubhangi Govindrao Wankhede	P
Diksha Devidas Bagde		Shweta Dilip Shende	P
Dipalee Raju Surwanshi		Tarun Arun Narekar	
Dipti Jayadeoji Ukunde	P	Vikas Babalu Arodiya	P
Dishant Vilas Bawankule		Anjali Vasantrya Durugkar	
Divya Kailash Bambodkar	P	Neha Bhaurao Bhalerao	P
Falguni Balardas Khobragade		Reshma Ramhari Fate	
Falguni Sudhakar Deshpande	P	Roshani Prabhakar Gajbhiye	P
Gajanan Annaji Godbole	P	Ashwajit Dipchand Kamble	
Garima Ghanshyam Rai	P		
Kajal Gautam Dabrase			
Kajal Narayan Neware	P		
Kajal Ranjan Mate	P		
Kalyani Prakash Wankhede	P		
Kavita Raju Jagtap			



Department of Computer Science Engineering

Session: 2019-20

Kunal Yogesh Shendre	P		
Kundanraj Jairaj Singh	P		
Kurvesh G. Sathawane			
Maresh Mahesh Singade	P		
Nandini Rajkumar Pillewar			
Nawaz Munawer Gazi			
Neha Bandu Patil	P		

Prof. Mahvash Khan
Event Co-ordinator

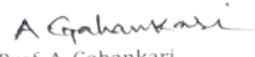
Prof. A. Gahankari
Head, CSE Deptt.
H.O.D.
Computer Science & Engineering Dept.
Nagpur Institute of Technology
Nagpur.



Department of Computer Science Engineering

Session: 2019-20

Date:13/06/2020

Notice

All the students are hereby informed that the, CSE Department is organizing **Webinar On "3 days Hands-on workshop on C sharp using Dot Net"** is schedule on **Date of event- 15 to 18-6-2020**. All the students must be present at the mentioned venue & time below.

Venue: Online Zoom Platform

Prof. Mohammad Sajid
Event Coordinator

Prof. A. Gahankari
Head, CSE Deptt.
H.O.D.
Computer Science & Engineering Dept.
Nagpur Institute of Technology
Nagpur.

Copy To :

1. Circulation in Class of VI Semester
2. Notice Board
3. Office file



Department of Computer Science Engineering
Session: 2019-20

Date - 18-6-2020

Report On "Hands-on workshop"

Name of Program - Hands-on workshop

Name of Department- Computer Science & Engineering

Name of organization- Nagpur Institute of Technology, Nagpur

Name of activity – 3 days Hands-on workshop on "C sharp using Dot Net".

Venue: Online Zoom Platform

Date of event-15 to 18-6-2020

Department of Computer Science & Engineering organized a 3 days hands-on workshop (from 15 to 18 June..17th June Session was conducted on 18th June due to some unavoidable circumstances) on "C sharp using Dot Net". The resource person was Mr.Nilesh Gupta,CEO,NRSolutions4u.com

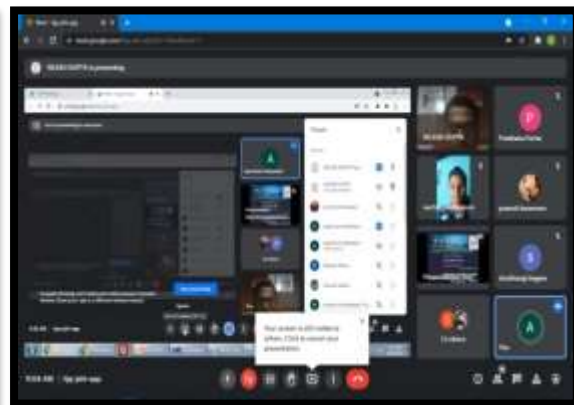

Prof. Mohammad Sajid
Event Coordinator

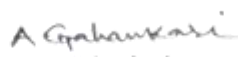
Prof. A. Gahankari
Head, CSE Deptt.
H.O.D.
Computer Science & Engineering Dept.
Nagpur Institute of Technology
Nagpur.



Department of Computer Science Engineering

Session: 2019-20

List Of Present Students from 3rd year			
NAME OF STUDENTS		NAME OF STUDENTS	
Abhijeet Dattaraj Shrikhande	P	Nikita Arun Samarth	
Abhishek Prasad Pandey	P	Prachi Baliram Thote	
Achal Yashwant Meshram		Pranali Yashwantrao Tirpude	P
Amit Naresh Bagde	P	Prateek Vijay Bheevgade	P
Amit Shatrughan Meshram	P	Pratiksha Ramuji Harle	P
Anjali Manoj Pathak	P	Prerna Mangal Wasnik	
Anjali Sanjay Kharapkar		Ravi Ranjan Singh	P
Ankita Madan Chawariya		Rohit Vijay Batho	
Ankush Nilknath Dhakate		Ruchira Parasram Shrikhande	P
Apurva Naresh Thaokar	P	Sarika Rakesh Chaturvedi	P
Arati Rupraoji Somkuwar	P	Saurabh Sunilrao Dhok	
Arnold Ernest Dsilva	P	Sejal Sanjay Chinchulkar	P
Bhagyashri Chhaganlal Borikar		Shruti Rajesh Kamble	
Bhavika Prabhakar Ghormade	P	Shubham Narayan DUBY	
Chetna C Likhari		Shubhangi Govindrao Wankhede	P
Diksha Devidas Bagde	P	Shweta Dilip Shende	P
Dipalee Raju Surwanshi	P	Tarun Arun Narekar	
Dipti Jayadeoji Ukunde		Vikas Babalu Arodiya	P
Dishant Vilas Bawankule	P	Anjali Vasanttrao Durugkar	
Divya Kailash Bambodkar		Neha Bhaurao Bhalerao	P
Falguni Balardas Khobragade	P	Reshma Ramhari Fate	
Falguni Sudhakar Deshpande		Roshani Prabhakar Gajbhiye	P
Gajanan Annaji Godbole	P	Ashwajit Dipchand Kamble	
Garima Ghanshyam Rai	P		
Kajal Gautam Dabrase			



Department of Computer Science Engineering

Session: 2019-20

Kajal Narayan Neware	P		
Kajal Ranjan Mate	P		
Kalyani Prakash Wankhede	P		
Kavita Raju Jagtap			
Kunal Yogesh Shendre	P		
Kundanraj Jairaj Singh	P		
Kurvesh G. Sathawane			
Maresh Mahesh Singade	P		
Nandini Rajkumar Pillewar			
Nawaz Munawer Gazi			
Neha Bandu Patil	P		

Prof. Mohammad Sajid
Event Coordinator

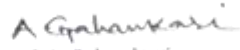
Prof. A. Gahankari
Head, CSE Deptt.
H.O.D.
Computer Science & Engineering Dept.
Nagpur Institute of Technology
Nagpur.



Department of Computer Science Engineering

Session: 2019-20

Date:12/05/2020

Notice

All the students are hereby informed that the, CSE Department is organizing **3 days webinar on "Wordpress"** is schedule on dated 15-5-2020 to 17-5-2020. All the students must be present at the mentioned venue & time below.

Online Zoom Platform

Prof. Mahvash Khan
Event Co-ordinator

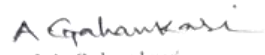
Prof. A. Gahankari
Head, CSE Deptt.
H.O.D.
Computer Science & Engineering Dept.
Nagpur Institute of Technology
Nagpur.

Copy To :

1. Circulation in Class of VIII Semester
2. Notice Board
3. Office File



Department of Computer Science Engineering

Session: 2019-20

Date: 17-5-2020

Report On "3 Day Workshop"

Name of Program - 3 Day Workshop

Name of Department- Computer Science & Engineering

Name of organization- Nagpur Institute of Technology, Nagpur

Name of activity –3 Day Workshop on Wordpress

Venue: Online Zoom Platform

Date of event-15-5-2020 to 17-5-2020, 5:00pm

Department of Computer Science & Engineering organized a 3 Day Workshop on Wordpress by Mr. Mohit Kewate 8th Semester Student. Students from all the semester attended and gained knowledge of wordpress technology. He has elaborated all the trends that are available in wordpress and discussed how website can be made more user friendly.



M Khan
Prof. Mahvash Khan
Event Co-ordinator

A Gahankari
Prof. A. Gahankari
Head, CSE Deptt.
H.O.D.
Computer Science & Engineering Dept.
Nagpur Institute of Technology
Nagpur.



Department of Computer Science Engineering

Session: 2019-20

List Of Present Students from 4 th year				
NAME OF STUDENTS			NAME OF STUDENTS	
ARCHANA NARENDRA SHRIVASTAVA	P	NILAM BAKELAL GAUTAM	P	
PRANJAL DARSHAN BHOWATE	P	AKSHAY MAHADEO ILKAR	P	
SONALI LALCHAND MESHRAM	P	KARISHMA CHAITRAM SAKHARE	P	
ABOLI TEKRAM MATE	P	ROSHANI SHIVAJI GOKHE		
SHUNOTTARA DHARMRAKSHIT SARADE	P	CHAITRALI PRAMOD TAGDE	P	
SURBHI ISHWARRAO SARODE	P	SHALINI RAJESH CHITARE		
PRAGATI GOSAVI BHAGAT		SANJANA MAHESH MESHRAM	P	
UJWAL PRAKASH MALIK	P	SAHIL DILIP DHOKE		
KUNAL ASHOK RAHANGDALE	P	ANJALI VINOD MANOHAR	P	
SHRUSHTI JAYANT KAWALE		ANIKET CHHOTELAL THAKRE	P	
NEHA KALENDRA RAWATE	P	PARAM RAJESH JANGAM		
ROHINI SHESHRAO GANORKAR		MAYURI RAJU BORKAR	P	
RASHMI ARUNJU GADIGONE		PRAVIN RAJKUMAR SHIVHARE		
SHUBHAM MADAN TINKHEDE	P	RAHUL RADHESHYAM SAHU	P	
SNEHA MOTIRAM GHODE	P	ANJALI MOHANSINGH THAKUR		
PANKAJ DILIP PATEL	P	SAYYAD TAUQIRALI SAJIDALI	P	
PRACHI MADAN SHENDE		PRATIKSHA VINOD INDURKAR		
PRASHANT RAJKUMAR RAMTEKE	P	TWINKLE DEVANAND KOKANDE	P	
PRAJAKTA DEOMAN HELONDE		PALLAVI KALYAN DONGRE		
AMIT SUDHIR DHARMIK	P	VRUSHABH SURESH GIRI	P	
NIKITA SHANKAR SHAHU		SAKSHI PADMAKAR BANSOD		
TEJASWINI RAJENDRA DHOMNE	P	APURVA SHANKAR GOUR	P	
VINIT SUDHIR MESHRAM		NITIN RAJENDRA MESHRAM		
MOHIT BHALCHANDRA KEWATE		RESHMA RAMHARI FATE		
SHUBHANGI VINOD BHARDWAJ	P	ROHAN DIPAK SONPIPARE		

Prof. Mahvash Khan
Event Co-ordinator

Prof. A. Gahankari
Head, CSE Deptt.
H.O.D.
Computer Science & Engineering Dept.
Nagpur Institute of Technology
Nagpur.



Department of Computer Science Engineering

Session: 2019-20

Date:29/04/2020

Notice

All the students are hereby informed that the, CSE Department is organizing **3 day Webinar On "Android"** is schedule on dated 1-05-2020. All the students must be present at the mentioned venue & time below.

Venue: Online Zoom Platform

Prof. Mahvash Khan
Event Co-ordinator

Prof. A. Gahankari
Head, CSE Deptt.

H.O.D.
Computer Science & Engineering Dept.
Nagpur Institute of Technology
Nagpur.

Copy To :

1. Circulation in Class of VIII Semester
2. Notice Board
3. Office File



Department of Computer Science Engineering
Session: 2019-20

Date -05-05-2020

Report On "3 day Workshop on Android"

Name of Program - 3 day Workshop
Name of Department- Computer Science & Engineering
Name of organization- Nagpur Institute of Technology, Nagpur
Name of activity -3 day Workshop on Android
Venue: Online Zoom Platform
Date of event-1-05-2020,4:00pm

Department of Computer Science & Engineering organized a 3 day Workshop on Android by Mr. Arjun Dalal, React Developer at OrangeBit Technology,pvt ltd Nagpur. Students from all the semester attended the webinar and gained knowledge of android technology.



M Khan
Prof. Mahvash Khan
Event Co-ordinator

A Gahankari
Prof. A. Gahankari
Head, CSE Deptt.
H.O.D.
Computer Science & Engineering Dept.
Nagpur Institute of Technology
Nagpur.



Department of Computer Science Engineering

Session: 2019-20

List Of Present Students from 4 th year			
NAME OF STUDENTS		NAME OF STUDENTS	
ARCHANA NARENDRA SHRIVASTAVA	P	NILAM BAKELAL GAUTAM	P
PRANJAL DARSHAN BHOWATE	P	AKSHAY MAHADEO ILKAR	P
SONALI LALCHAND MESHARAM	P	KARISHMA CHAITRAM SAKHARE	P
ABOLI TEKRAM MATE	P	ROSHANI SHIVAJI GOKHE	
SHUNOTTARA DHARMAKSHIT SARADE	P	CHAITRALI PRAMOD TAGDE	P
SURBHI ISHWARRAO SARODE	P	SHALINI RAJESH CHITARE	
PRAGATI GOSAVI BHAGAT		SANJANA MAHESH MESHARAM	P
UJWAL PRAKASH MALIK	P	SAHIL DILIP DHOKE	
KUNAL ASHOK RAHANGDALE	P	ANJALI VINOD MANOHAR	P
SHRUSHTI JAYANT KAWALE		ANIKET CHHOTELAL THAKRE	P
NEHA KALENDRA RAWATE	P	PARAM RAJESH JANGAM	
ROHINI SHESHRAO GANORKAR		MAYURI RAJU BORKAR	P
RASHMI ARUNJU GADIGONE		PRAVIN RAJKUMAR SHIVHARE	
SHUBHAM MADAN TINKHEDE	P	RAHUL RADHESHYAM SAHU	P
SNEHA MOTIRAM GHODE	P	ANJALI MOHANSINGH THAKUR	
PANKAJ DILIP PATEL	P	SAYYAD TAUQIRALI SAJDALI	P
PRACHI MADAN SHENDE		PRATIKSHA VINOD INDURKAR	
PRASHANT RAJKUMAR RAMTEKE	P	TWINKLE DEVANAND KOKANDE	P
PRAJAKTA DEOMAN HELONDE		PALLAVI KALYAN DONGRE	
AMIT SUDHIR DHARMIK	P	VRUSHABH SURESH GIRI	P
NIKITA SHANKAR SHAHU		SAKSHI PADMAKAR BANSOD	
TEJASWINI RAJENDRA DHOMNE	P	APURVA SHANKAR GOUR	P
VINIT SUDHIR MESHARAM		NITIN RAJENDRA MESHARAM	
MOHIT BHALCHANDRA KEWATE		RESHMA RAMHARI FATE	
SHUBHANGI VINOD BHARDWAJ	P	ROHAN DIPAK SONPIPARE	

Prof. Mahvash Khan
Event Co-ordinator

Prof. A. Gahankari
Head, CSE Deptt.
H.O.D.
Computer Science & Engineering Dept.
Nagpur Institute of Technology
Nagpur.



Shri Sai Shikshan Sanstha's
NAGPUR INSTITUTE OF TECHNOLOGY, NAGPUR
Survey No.13/2, Mahurzari, Near Fetri, Katol Road Nagpur-441501
Email: info@nit.edu.in, Tel: 08275010512, 08275010559



Department of Civil Engineering
Session: 2019-20

Date: 07-09-2019

NOTICE

Department of Civil Engineering organizing Seminar on 2 Days workshop on the topic on "Design Software's in Civil Engineering" for the students of Third year and Fourth year. All are informed to be remain present on 09-09-2019 and 10-09-2019 in Room E-104.

Prof. J. H. Gurnani
Co-ordinator workshop

Dr. A. L. Murmu
HOD Civil Engg.

Head of Department
Civil Engineering
Nagpur Institute of Technology
Nagpur

Copy To:

- 1) Principal
- 2) HOD CE
- 3) Class incharge 2nd Year
- 4) Class incharge 3rd Year



Shri Sai Shikshan Sanstha's
NAGPUR INSTITUTE OF TECHNOLOGY, NAGPUR
Survey No.13/2, Mahurzari, Near Fetri, Katol Road Nagpur-441501
Email: info@nit.edu.in, Tel: 08275010512, 08275010559



Department of Civil Engineering
Session: 2019-20

Date:- 11.09.2019

2 Days workshop on Design Software's in Civil Engineering

Civil Engineering Department, organized 2 Days workshop under forum of Civil Engineering Students Association (CESA) on the topic on Design Software's in Civil Engineering on date 09-09-2019 and 10-09-2019 at Nagpur Institute of Technology, Nagpur. Mr. Nitin & Ms. Anjali deliver the lecture and successfully conducted the session with power point presentation and shared his personal experiences and knowledge with the students. Total 60 students were present for attending the Lecture. Finally the session was ended by Prof. C. N. Gawali with vote of thanks.



Prof. J. H. Gurnani
(Co-ordinator)

Dr. A. L. Murmu
(HOD, Civil Engg.Dept.)
**Head of Department
Civil Engineering
Nagpur Institute of Technology
Nagpur**



Department of Civil Engineering
Session: 2019-20

Name of the Activity :- Two Days workshop on Design Software's in Civil Engineering

Activity Attendance Sheet Fifth Semester

Date :- 09-09-2019 and 10-

09-2019

CR N	Name of Student	ATT .
301	Akanksha Njanbandhu	P
302	Bharati R Bhujade	P
303	Bhawana Jaydeo Agalawe	
304	Damini Sangole	P
305	Deepika A Chinchkhede	
306	Diksha Deepak Tirpude	P
307	Gouri B Bhajikhaye	
308	Neha Dilip Kamble	
309	Payal Dhiraj Walde	P
310	Pranali Dinesh Gedam	
311	Priyanka V Tembhurnikar	P
312	Rutuja Dinesh Khaparde	
313	Sejal Manoj Suryawanshi	
314	Shital Ramesh Raut	P
315	Shraddha V Bhusari	
316	Shreya Bhaurao Gadlinge	P
317	Shubha Dhore	
318	Sonal Prabhakar Damle	P
319	Srushti Ashok Thawkar	P
320	Tejswi Somkuwar	
321	Abhinav Ramteke	P
322	Abhishek K Guntewar	P
323	Adarsh Rajesh Ambade	
324	Aditya K Ghormade	P
325	Akash Vishwanath Gaikwad	
326	Akash Zanak Khandate	P

CRN	Name of Student	ATT .
337	Harshal N Thakare	P
338	Jay Ravikant Prajapati	
339	Mayur Dilip Chaurse	P
340	Mayur G Bawankule	P
341	Md. Taha Wasi	
342	Miran Khan	
343	Montu Domanlal Shahu	P
344	Montu T Motghare	
345	Mukesh Demdhe	
346	Nayan Ratan Yangalwar	
347	Onkar Rudraji Khupse	P
348	Pradeep Nishad	
349	Prajwal Rwakodikar	P
350	Pranay P Landge	
351	Rohit Subhash Togarwar	
352	Rushikesh Hiwraj Baladhare	P
353	Sahil Ganesh Nakade	
354	Samir M Mandaodhare	
355	Sanket Vijay Shastri	P
356	Shivam Rewatkar	P
357	Shivam Ghode	P
358	Shriram Anant Mahajan	
359	Shubham Devidas Bante	P
360	Shubham Jagprasad Sharma	
361	Shubham S Narnaware	
362	Shubham Suresh Parate	



Shri Sai Shikshan Sanstha's
NAGPUR INSTITUTE OF TECHNOLOGY, NAGPUR
Survey No.13/2, Mahurzari, Near Fetri, Katol Road Nagpur-441501
Email: info@nit.edu.in, Tel: 08275010512, 08275010559



Department of Civil Engineering
Session: 2019-20

327	Amit Digambar Ingle		363	Siddhesh Khode	
328	Aniket Kishorrao Walke	P	364	Suraj Pramod Raut	
329	Anshul P Dhanvijay		365	Tanmay Pramod Wagh	
330	Ashish Vitthal Meshram	P	366	Tejas Mohan Wararkar	
331	Ashwajeet Kishor Wasnik		367	Umair Anwar M Ashafaque	
332	Bharat C Kolhe		368	Vaidip Barsagade	P
333	Chandahas C Bandhekar	P	369	Vedant Sanjay Keche	
334	Chetan L Tembhare		370	Vishal Bimlesh Arodiya	P
335	Gaurav Meghashyam Pardhi		371	Vrushabh Anil Raghusha	
336	Harshal Sunil Meshram				

Prof. J. H. Gurnani
(Co-ordinator)

Dr. A. L. Murmu
(HOD, Civil Engg.Dept.)
**Head of Department
Civil Engineering
Nagpur Institute of Technology
Nagpur**



SHRI SAI SHIKSHAN SANSTHA'S
NAGPUR INSTITUTE OF TECHNOLOGY, NAGPUR
(Approved By AICTE New Delhi & DTE Mumbai(Govt.Of Maharashtra and Affiliated To
Rashtrasant Tukadoji Maharaj NagpurUniversity,Nagpur)
Campus: Survey No.13/2 ,Mahurzari , Near Fetri , Katol Road , Nagpur-441501(INDIA)

Department of Electrical Engineering

Session 2019-20 Notice/Circular

Date:25/02/2020

All the students of Electrical Engineering are hereby informed that the Department of Electrical Engineering is organizing the “2 Days Online Workshop on PV Solar” on 28-02-2020 to 29-02-2020. The students of Electrical Engineering should attend and actively participate in the event.

Prof. R. V. Lonare
Coordinator

Dr. J. G. Chadhuri

HoD, Electrical
H. O. D.

Department of Electrical Engg.
Nagpur Institute of Technology

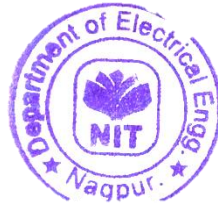

Copy To:

The Principal,NIT, Nagpur
The Dean(Academics),NIT,Nagpur



SHRI SAI SHIKSHAN SANSTHA'S
NAGPUR INSTITUTE OF TECHNOLOGY, NAGPUR
(Approved By AICTE New Delhi & DTE Mumbai(Govt.Of Maharashtra and Affiliated To
Rashtrasant Tukadoji Maharaj NagpurUniversity,Nagpur)
Campus: Survey No.13/2 ,Mahurzari , Near Fetri , Katol Road , Nagpur-441501(INDIA)

Department of Electrical Engineering

Session 2019-20 Activity Report

Date: 29/02/2020

Topic : Online Workshop on PV Solar
Expert : Mr. Shrikant Ganjare, Co-Founder, Think solar Nagpur
Date : 28-02-2020 to 29-02-2020.

Details of Participants: HOD, all teaching faculties of Electrical Engineering Department and Third (5thSem) and Final Year (7thSem) Students

Aim :To deliver key aspects in Workshop on PV Solar

Objectives : This Seminar will learn the following:
To understand Workshop on PV Solar

Introduction:

Department of Electrical Engineering , Nagpur Institute of Technology, Nagpur organized a Workshop as part of curriculum based on “Workshop on PV Solar” for the 3rd and Final Year (BE) Electrical Engineering Students on 28-02-2020 to 29-02-2020. Expert was Mr. Shrikant Ganjare, Co-Founder, Think solar Nagpur. The Guest delivered the Session considering future aspects to Research in Solar and its design with applications as in today's era.

Outcome of Seminar:

Students get to know theoretical and Practical part of Solar to fill the gap between academic and industry

Conclusion:

Students get knowledge about Solar PV Installation Theoretically and Practically.

Acknowledgment:

On behalf of the Electrical Engineering Department we sincerely thank Mr. Shrikant Ganjare, Co-Founder, Think solar Nagpur for accepting our invitation and Taking Workshop on “Solar PV ”to our students.

Our deep sense of gratitude to Dr. Amol Deshmukh, Principal, N.I.T. for providing support in organizing the Seminar.



SHRI SAI SHIKSHAN SANSTHA'S
NAGPUR INSTITUTE OF TECHNOLOGY, NAGPUR
(Approved By AICTE New Delhi & DTE Mumbai(Govt.Of Maharashtra and Affiliated To
Rashtrasant Tukadoji Maharaj NagpurUniversity,Nagpur)
Campus: Survey No.13/2 ,Mahurzari , Near Fetri , Katol Road , Nagpur-441501(INDIA)

Department of Electrical Engineering

Session 2019-20

Event Photos:

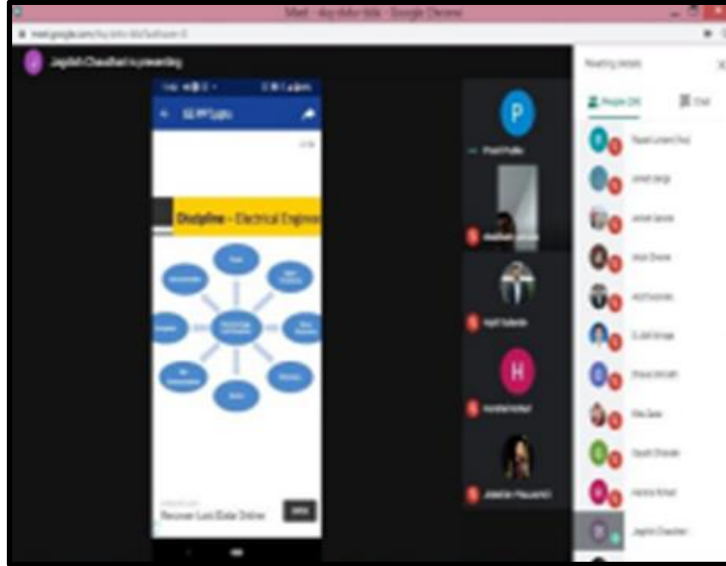

R. V. Lonare

Prof. R. V. Lonare
Coordinator

J. G. Chadhuri

Dr. J. G. Chadhuri

HoD, Electrical

H. O. D.

Department of Electrical Engg.
Nagpur Institute of Technology

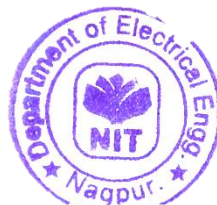



SHRI SAI SHIKSHAN SANSTHA'S
NAGPUR INSTITUTE OF TECHNOLOGY, NAGPUR
(Approved By AICTE New Delhi & DTE Mumbai (Govt. Of Maharashtra and Affiliated To
Rashtrasant Tukadoji Maharaj Nagpur University, Nagpur)
Campus: Survey No.13/2, Mahurzari, Near Fetri, Katol Road, Nagpur-441501 (INDIA)

Department of Electrical Engineering

Session 2019-20

Date: 27/02/2020

Activity Attendance Sheet

Topic: - Online Workshop on PV Solar

Expert Name & Designation: Mr. Shrikant Ganjare, Co-Founder, Think solar Nagpur

Year: Final Year

Roll No.	Name of Students	Att Day 1	Att Day 2
401	Amita Vasantao Meshram	P	P
402	Anju Rupchand Chavhan	P	P
403	Deepali Kewalram Koche	P	P
404	Durga Sangamjeet Banjare	P	P
405	Megha Banduji Doye	P	P
406	Megha Dnyaneshwar Badge	P	
407	Pallavi Narendra Bansod	P	P
408	Pallavi Rajendra Dardemal	P	P
409	Payal Chandrakant Bhagat	P	
410	Pratiksha Shubhash Elamkar	P	P
411	Priya Ravindra Meshram	P	P
412	Rani Domaji Thakre	P	
413	Savita Kanhailal Sarode		P
414	Shyamli Sunil Jambhulkar	P	P
415	Sonal Anand Jarad	P	
416	Upasana Bhupendra Humne	P	P
417	Urwashi Moreshwar Chikhale		P
418	Veena Parasram Chudhari	P	P
419	Ajay Mahadeorao Ingole		P
420	Akshay Ratnakar Gotmare	P	
421	Ashwin Purushottam Ganvir	P	P
422	Bhushan Chudaman Parate		P
423	Chetan Bhagawan Asole	P	
424	Chetan Sureshrao Tabhane		P
425	Darshan Hemant Mehare	P	P
426	Dinesh Laxman Chunarkar		P



SHRI SAI SHIKSHAN SANSTHA'S
NAGPUR INSTITUTE OF TECHNOLOGY, NAGPUR
(Approved By AICTE New Delhi & DTE Mumbai(Govt.Of Maharashtra and Affiliated To
Rashtrasant Tukadoji Maharaj NagpurUniversity,Nagpur)
Campus: Survey No.13/2 ,Mahurzari , Near Fetri , Katol Road , Nagpur-441501(INDIA)

Department of Electrical Engineering

Session 2019-20

427	Dnyaneshwar Ishwar Belkhede		P
428	Ganesh Sunil Kunghadkar	P	P
429	Gaurao Chudaman Parate		P
430	Mahesh Kashinath Punatkar	P	P
431	Piyush Ashok Bhagwatkar	P	P
432	Rajat Rajesh Gadhave	P	P
433	Rajat Sanjay Bahadure		P
434	Rushikesh Prashant Umak	P	P
435	Subodh Mukesh Gajbhiye	P	P
436	Suraj Jagdish Ghorle	P	P
437	Vaibhav Anil Ukey	P	P
438	Vikram Dhanraj Kalambe	P	P
439	Vinod Dilipraoji Bhoyar	P	P

Prof. R. V. Lonare
Coordinator

Dr. J. G. Chadhuri
HoD, Electrical



SHRI SAI SHIKSHAN SANSTHA'S
NAGPUR INSTITUTE OF TECHNOLOGY, NAGPUR
(Approved By AICTE New Delhi & DTE Mumbai(Govt.Of Maharashtra and Affiliated To
Rashtrasant Tukadoji Maharaj NagpurUniversity,Nagpur)
Campus: Survey No.13/2 ,Mahurzari , Near Fetri , Katol Road , Nagpur-441501(INDIA)

Department of Electrical Engineering

Session 2019-20 Notice/Circular

Date:26/02/2020

All the students of Electrical Engineering are hereby informed that the Department of Electrical Engineering is organizing the seminar on "Drawing Software for Electrical Engineers" on 27 February 2020 at 10.00 a.m. The students of third year and final year of Electrical Engineering should attend and actively participate in the event.

Prof. R. V. Lonare
Coordinator

Dr. J. G. Chadhuri

HoD, Electrical

H. O. D.

Department of Electrical Engg.
Nagpur Institute of Technology

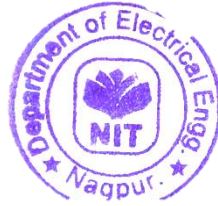

Copy To:

- 1) The Principal,NIT, Nagpur
- 2) The Dean(Academics),NIT,Nagpur



SHRI SAI SHIKSHAN SANSTHA'S
NAGPUR INSTITUTE OF TECHNOLOGY, NAGPUR
(Approved By AICTE New Delhi & DTE Mumbai(Govt.Of Maharashtra and Affiliated To
Rashtrasant Tukadoji Maharaj NagpurUniversity,Nagpur)
Campus: Survey No.13/2 ,Mahurzari , Near Fetri , Katol Road , Nagpur-441501(INDIA)

Department of Electrical Engineering

Session 2019-20 Activity Report

Date: 27/02/2020

Topic of Seminar: Drawing Software for Electrical Engineers

Expert: Er. Akash A. Thakre, Electrical Design Engineer, Astral Informatics Pvt. Ltd, Nagpur

Date: 27th February 2020

Details of Participants: HOD, all teaching faculties of Electrical Engineering Department, 6th and 8th semester Electrical Engg. Students.

Aim: To bestow the students with knowledge and latest technical updates about Drawing Softwares for Electrical Engineering.

Objective:

- 1) To understand basics of Electrical Drawings and its use in engineering.
- 2) To study various drawing softwares.

Introduction:

Department of Electrical Engineering, Nagpur Institute of Technology, Nagpur organized a Guest Seminar as part of curriculum based on “Drawing Softwares for Electrical Engineers” for the ‘6th and 8th Semester(BE) Electrical Engineering Students on 27th February 2020. Expert faculty - Er. Akash A. Thakre, Electrical Design Engineer, Astral Informatics Pvt. Ltd, Nagpur. The Guest made the students acquainted with Drawing Softwares for Electrical Engineers.

Outcome of Seminar:

1. The Seminar cleared the basic knowledge regarding drawing software.
2. Students are provided with some demo software to draw simulation diagrams.

Conclusion:

Outcomes of the Seminar were fulfilled and students benefited as they got to know about the software.

Acknowledgment:

- 1) On behalf of the Electrical Engineering Department we sincerely thank Er. Akash A. Thakre, Electrical Design Engineer, Astral Informatics Pvt. Ltd, Nagpur for accepting our invitation and delivering Seminar on “Drawing Softwares for Electrical Engineers” to our students from Curriculum, Research and Application point of view.



SHRI SAI SHIKSHAN SANSTHA'S
NAGPUR INSTITUTE OF TECHNOLOGY, NAGPUR
(Approved By AICTE New Delhi & DTE Mumbai(Govt.Of Maharashtra and Affiliated To
Rashtrasant Tukadoji Maharaj NagpurUniversity,Nagpur)
Campus: Survey No.13/2 ,Mahurzari , Near Fetri , Katol Road , Nagpur-441501(INDIA)

Department of Electrical Engineering

Session 2019-20

- 2) Our deep sense of gratitude to Dr. Amol Deshmukh, Principal, NIT, Nagpur for providing support in organizing the guest Seminar.

Event Photos:

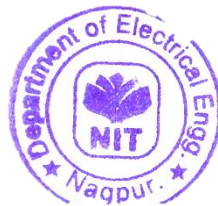

Photo: Guest delivering the Seminar

Prof. R. V. Lonare
Coordinator

Dr. J. G. Chadhuri
HoD, Electrical
H. O. D.

Department of Electrical Engg.
Nagpur Institute of Technology





SHRI SAI SHIKSHAN SANSTHA'S
NAGPUR INSTITUTE OF TECHNOLOGY, NAGPUR
(Approved By AICTE New Delhi & DTE Mumbai(Govt.Of Maharashtra and Affiliated To
Rashtrasant Tukadoji Maharaj Nagpur University, Nagpur)
Campus: Survey No.13/2 ,Mahurzari , Near Fetri , Katol Road , Nagpur-441501(INDIA)

Department of Electrical Engineering

Session 2019-20

Date: 27/02/2020

Activity Attendance Sheet

Topic: - Drawing Software for Electrical Engineers

Expert Name & Designation: Er. Akash A. Thakre, Electrical Design Engineer, Astral Informatics Pvt. Ltd, Nagpur

Year: Final Year

Roll No.	Name of Students	Att	Roll No.	Name of Students	Att
401	Amita Vasanttrao Meshram	P	421	Ashwin Purushottam Ganvir	P
402	Anju Rupchand Chavhan	P	422	Bhushan Chudaman Parate	
403	Deepali Kewalram Koche	P	423	Chetan Bhagawan Asole	P
404	Durga Sangamjeet Banjare	P	424	Chetan Sureshrao Tabhane	
405	Megha Banduji Doye	P	425	Darshan Hemant Mehare	P
406	Megha Dnyaneshwar Badge	P	426	Dinesh Laxman Chunarkar	
407	Pallavi Narendra Bansod	P	427	Dnyaneshwar Ishwar Belkhede	
408	Pallavi Rajendra Dardemal	P	428	Ganesh Sunil Kunghadkar	P
409	Payal Chandrakant Bhagat	P	429	Gaurao Chudaman Parate	
410	Pratiksha Shubhash Elamkar	P	430	Mahesh Kashinath Punatkar	P
411	Priya Ravindra Meshram	P	431	Piyush Ashok Bhagwatkar	P
412	Rani Domaji Thakre	P	432	Rajat Rajesh Gadhawe	P
413	Savita Kanhailal Sarode		433	Rajat Sanjay Bahadure	
414	Shyamli Sunil Jambhulkar	P	434	Rushikesh Prashant Umak	P
415	Sonal Anand Jarad	P	435	Subodh Mukesh Gajbhiye	P
416	Upasana Bhupendra Humne	P	436	Suraj Jagdish Ghorle	P
417	Urwashi Moreshwar Chikhale		437	Vaibhav Anil Ukey	P
418	Veena Parasram Chudhari	P	438	Vikram Dhanraj Kalambe	P
419	Ajay Mahadeorao Ingole		439	Vinod Dilipraoji Bhojar	P
420	Akshay Ratnakar Gotmare	P			

Prof. R. V. Lonare
Coordinator

Dr. J. G. Chadhuri
HoD, Electrical



SHRI SAI SHIKSHAN SANSTHA'S
NAGPUR INSTITUTE OF TECHNOLOGY, NAGPUR
(Approved By AICTE New Delhi & DTE Mumbai(Govt.Of Maharashtra and Affiliated To
Rashtrasant Tukadoji Maharaj NagpurUniversity,Nagpur)
Campus: Survey No.13/2 ,Mahurzari , Near Fetri , Katol Road , Nagpur-441501(INDIA)

Department of Electrical Engineering

Session 2019-20 Notice/Circular

Date:17/09/2019

All the students of Electrical Engineering are hereby informed that the Department of Electrical Engineering is organizing the 2 days' Workshop on "Simulation of Power Converter using MATLAB" on 19-09-2019 to 20-09-2019 . The students of Electrical Engineering should attend and actively participate in the event.

Prof. R. V. Lonare
Coordinator

Dr. J. G. Chadhuri
HoD, Electrical

H. O. D.

Department of Electrical Engg.
Nagpur Institute of Technology



Copy To:

The Principal,NIT, Nagpur
The Dean(Academics),NIT,Nagpur



SHRI SAI SHIKSHAN SANSTHA'S
NAGPUR INSTITUTE OF TECHNOLOGY, NAGPUR
(Approved By AICTE New Delhi & DTE Mumbai(Govt.Of Maharashtra and Affiliated To
Rashtrasant Tukadoji Maharaj Nagpur University, Nagpur)
Campus: Survey No.13/2 ,Mahurzari , Near Fetri , Katol Road , Nagpur-441501(INDIA)

Department of Electrical Engineering

Session 2019-20 Activity Report

Date: 20/09/2019

Topic : Simulation of Power Converter using MATLAB
Expert : Dr. M .M.Renge, Professor, Electrical Engineering, RCoEM, Nagpur
Date : 19-09-2019 to 20-09-2019

Details of Participants: HOD, all teaching faculties of Electrical Engineering Department and Third (5thSem) and Final Year (7thSem) Students

Aim :To deliver key aspects in Simulation of Power Converter using MATLAB

Objectives : This Seminar will learn the following:

- 1) To understand Simulation of Power Converter using MATLAB

Introduction:

Department of Electrical Engineering , Nagpur Institute of Technology, Nagpur organized a Workshop as part of curriculum based on “Simulation of Power Converter using MATLAB” for the 3rd and Final Year (BE) Electrical Engineering Students on 19-09-2019 to 20-09-2019. Expert faculty was Dr. M .M.Renge, Professor, Electrical Engineering, RCoEM, Nagpur. The Guest delivered key aspects in Simulation of Power Converter using MATLAB

Outcome of Seminar:

Students get aware about the power Converters in Electrical Engineering
Students understood the Simulation of Power Converter using MATLAB .

Conclusion:

Students benefited as they got knowledge relevant to Simulation of Power Converter using MATLAB

Acknowledgment:

On behalf of the Electrical Engineering Department we sincerely thank Dr. M .M.Renge, Professor, Electrical Engineering, RCoEM, Nagpur for accepting our invitation and Taking Workshop on “Simulation of Power Converter using MATLAB”to our students.

Our deep sense of gratitude to Dr. Amol Deshmukh, Principal, N.I.T. for providing support in organizing the Seminar.



SHRI SAI SHIKSHAN SANSTHA'S
NAGPUR INSTITUTE OF TECHNOLOGY, NAGPUR
 (Approved By AICTE New Delhi & DTE Mumbai(Govt.Of Maharashtra and Affiliated To
 Rashtasant Tukadoji Maharaj NagpurUniversity,Nagpur)
 Campus: Survey No.13/2 ,Mahurzari , Near Fetri , Katol Road , Nagpur-441501(INDIA)

Department of Electrical Engineering

Session 2019-20

Event Photos:

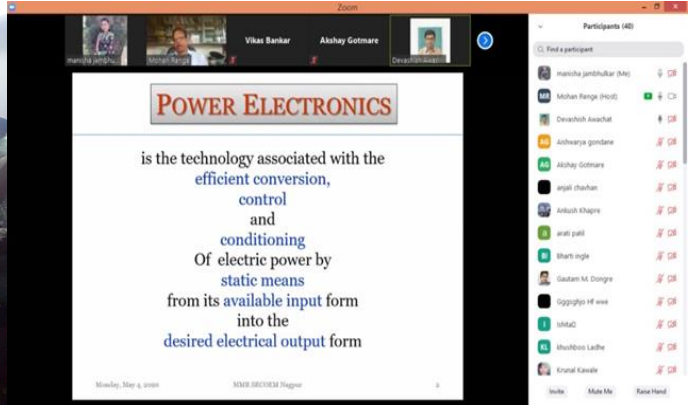

R.V.

Prof. R. V. Lonare
Coordinator

J.G.

Dr. J. G. Chadhuri
HoD, Electrical
H. O. D.

Department of Electrical Engg.
Nagpur Institute of Technology





SHRI SAI SHIKSHAN SANSTHA'S
NAGPUR INSTITUTE OF TECHNOLOGY, NAGPUR
(Approved By AICTE New Delhi & DTE Mumbai (Govt. Of Maharashtra and Affiliated To
Rashtrasant Tukadoji Maharaj Nagpur University, Nagpur)
Campus: Survey No.13/2, Mahurzari, Near Fetri, Katol Road, Nagpur-441501 (INDIA)

Department of Electrical Engineering

Session 2019-20

Date:-20/09/2019.

Activity Attendance Sheet

Topic: - Workshop on "Simulation of Power Converter using MATLAB"

Expert Name & Designation: Dr. M. M. Renge, Professor, Electrical Engineering, RCoEM, Nagpur

Year: Third Year

Roll. No.	Name of Student	Att. Day 1	Att. Day 2
301	Aachal Sanjay Borkar	P	P
302	Aishwarya Devendra Gondane	P	P
307	Ankita Narendra Gaikwad	P	P
308	Arati Rajendra Patil	P	P
309	Aruna Kamaldas Parteti	P	P
310	Bhumika Gajanan Bodhake	P	P
311	Komal Durwas Behaniya	P	P
312	Krutika Bhimsen Isalwar	P	P
313	Namrata Prakash Nakhale	P	P
317	Payal Rajesh Tayade	P	P
324	Rani Ghanshyam Khirwar	P	P
325	Rani Moreshwar Birkhede	P	P
326	Ruchika Sushil Chaware	P	
327	Sayali Sheshrao Kuhite	P	P
328	Shital Prakash Thombre	P	P
329	Shweta Rahul Tamgadge	P	P
330	Sneha Suresh Badodekar	P	P
331	Tejaswini Sunil Doye	P	P
332	Vaishali Durvesh Behaniya	P	P
333	Vinadevi Gangadhar Shendre	P	P
334	Abhay Vinayak Khorgade	P	P



SHRI SAI SHIKSHAN SANSTHA'S
NAGPUR INSTITUTE OF TECHNOLOGY, NAGPUR
(Approved By AICTE New Delhi & DTE Mumbai(Govt.Of Maharashtra and Affiliated To
Rashtrasant Tukadoji Maharaj Nagpur University, Nagpur)
Campus: Survey No.13/2 ,Mahurzari , Near Fetri , Katol Road , Nagpur-441501(INDIA)

Department of Electrical Engineering

Session 2019-20

335	Aniket Narendra Marotkar	P	P
336	Bablu Sohanlal Nikhar	P	P
341	Krunal Shankar Kawale	P	P
342	Manish Ramu Mohadikar	P	
343	Nagarjun Rajkumar Kotangale	P	P
344	Narendra Kachru Chourihar	P	P
345	Nehal Anandrao Narnaware	P	P
346	Nikhil Vijay Gajbhiye	P	P

Prof. R. V. Lonare
Coordinator

Dr. J. G. Chadhuri
HoD, Electrical